

ANAFI USA GOV

FreeFlight 6 USA User Guide

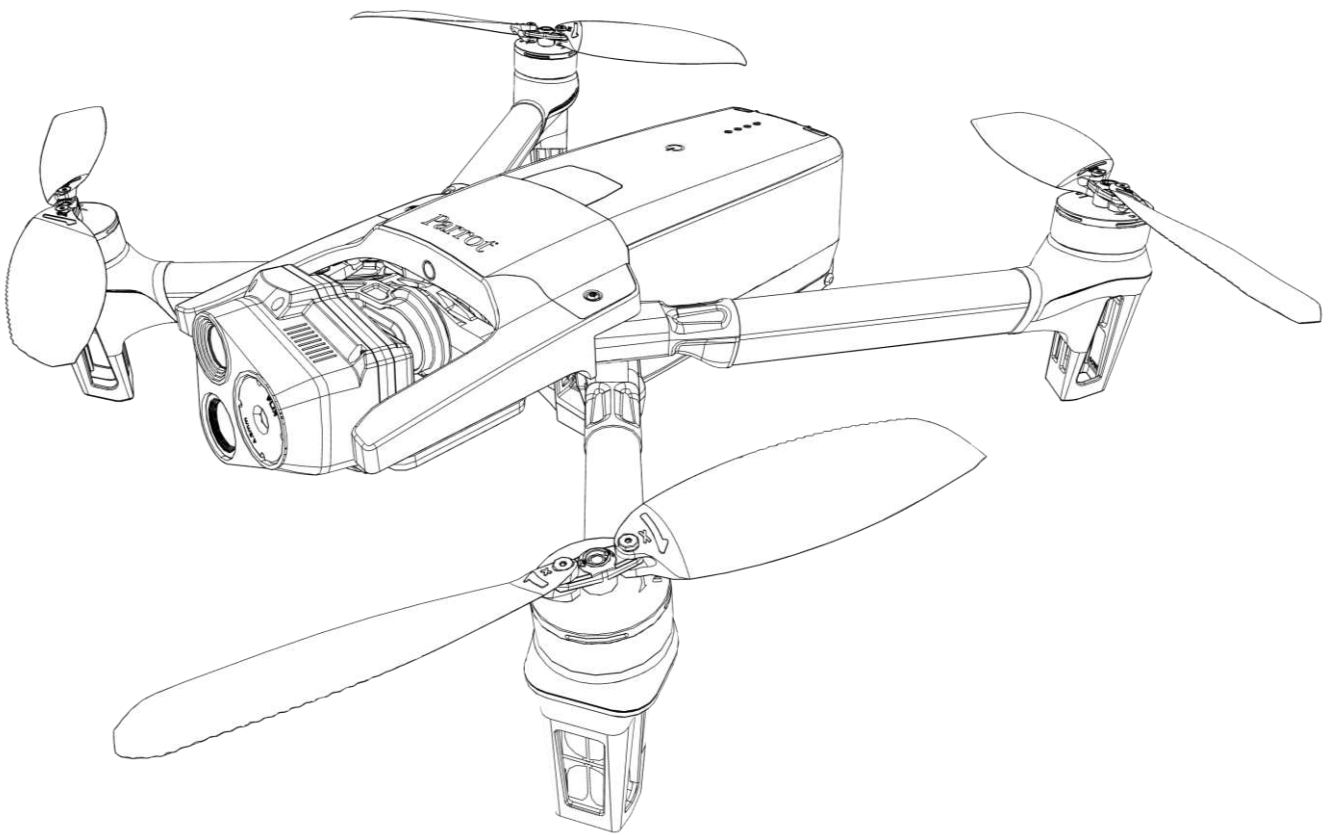

Version: 6.10.3.0

Updated: April, 4th, 2024

Parrot

Documentation changelog

This section details the major changes to Parrot’s technical documentation since the previous update.

What changed	Where
Images updated	Throughout guide
Technical specifications chapter updated	Page 12
MicroSD card and media management chapter updated	Page 40
Videos, photos, and panoramas chapter updated	Page 55

Using this guide

Parrot recommends that you read the following user guide thoroughly before your first flight. This user guide completes the ANAFI USA documentation, which also includes the:

- ANAFI USA [Flight Safety Guide](#);
- ANAFI USA and FreeFlight 6 USA [release notes](#);
- ANAFI USA [Video Tutorials](#).

Read the Flight Safety Guide provided with the ANAFI USA to have complementary information about safety, operational limitations for use and maintenance of the drone. Always verify that you are using the latest version of the [User Guide](#).

This guide is specific to a single drone configuration, consisting of:

- The ANAFI USA GOV drone (named ANAFI USA in this user guide for clarity)
- The Parrot Skycontroller USA (named Skycontroller USA in this user guide for clarity)
- The FreeFlight 6 USA flight application.

NOTE: ANAFI USA requires the FreeFlight 6 USA app to fly, and to ensure that the drone and controller are fully up to date with the latest features.

- **Read entirely at least once.** It answers most questions that most users encounter when they use ANAFI USA.
- **Keep it for reference and stay alert for updates.** These updates are mandatory and must be systematically performed prior to any flight to ensure maximum performance and safety.
- **The Table of contents, on page 6, is active.** Click a title to access the corresponding section.
- **This online user guide has no index.** Use the keyboard shortcut **Ctrl + F** (Windows) or **Command + F** (Mac) to browse all occurrences of any keyword (flight, preferences, gimbal, GeoTIFF, Flir, Boson®, photo, EV, ISO, and so on).

IMPORTANT: Parrot strongly recommends that you regularly refer to the [Release Notes ANAFI USA](#) available on the Parrot website, to ensure that you have the latest versions of the drone and controller firmware, and FreeFlight 6 USA App. If you are an offline user, you must contact your local Parrot Partner or Parrot Contact to obtain the .apk file to perform an offline system update.

Refer to the "[FreeFlight 6 USA offline update via APK file](#)" chapter for more information.

Prerequisites

Refer to the enclosed Super Quick Start Guide (SQSG) if you require illustrated guidance for the prerequisites.

1. Wake up the ANAFI USA's smart battery. Charge the battery using one of the enclosed USB-A to USB-C cables and the enclosed charger. The battery's LEDs start to flash indicating that the battery is awake. Let it charge. Parrot recommends you always run a full charge of the smart battery, and the Skycontroller USA before flying ANAFI USA.
2. Press the Skycontroller USA's power button for three seconds to power it on. Recharge it by connecting its USB-C port to a power source in order to start the update. ANAFI USA's controller is also a powerful Android tablet, dedicated to your aerial missions.

TIP: You can adjust the brightness of your screen to your flight conditions.

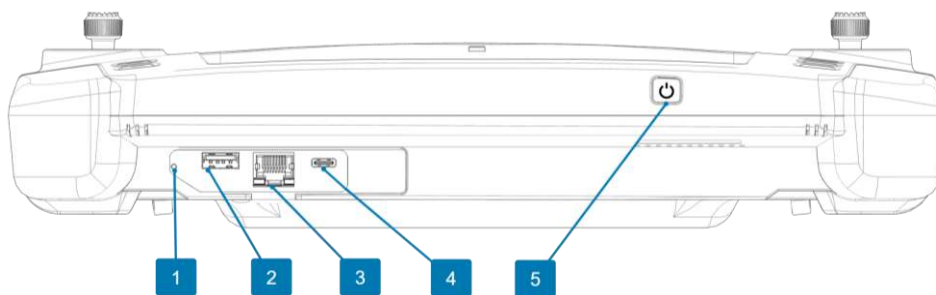

- | | |
|---|---------------|
| 1. Reset button | 4. USB-A port |
| 2. RJ45 port | 5. USB-C port |
| 3.  Power button | |

NOTE: On the underside of Skycontroller USA, numbers 1-4 are found under the watertight cover.

For more information, refer to the "[Presentation of Skycontroller USA](#)" section.

3. If permitted in your configuration, Parrot recommends you connect the Skycontroller USA integrated tablet to a network over Wi-Fi to perform the required updates (operating system, Android applications, etc.) and to begin personalizing it.

The fully secure piloting software of ANAFI USA, FreeFlight 6 USA, guarantees the integrity of data exchanges for the full ecosystem, and manages updates (piloting software, drone, remote control).

FreeFlight 6 USA is preinstalled on Skycontroller USA.



NOTE: FreeFlight 6 USA is the more recent app optimized specifically for ANAFI USA users. If your Skycontroller USA has FreeFlight 6 USA installed instead of FreeFlight 6 USA, you can download FreeFlight 6 USA on the Skycontroller USA's integrated tablet directly from the Play Store. Alternatively, contact your Parrot reseller who upon request can provide you with the application APK file.

Refer to the “[Skycontroller USA Maintenance Mode](#)” section for more information on how to update the application offline with APK file.

4. On ANAFI USA, remove the gimbal’s protective cover.
5. Press and hold ANAFI USA’s  **Power** button for approximately 1 second to power it on. The drone’s fan starts to turn.

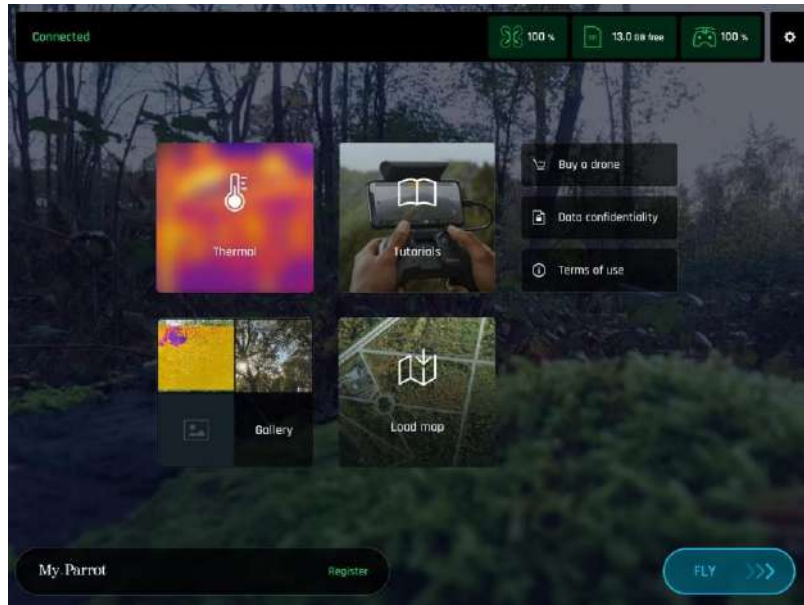

6. On Skycontroller USA, tap the app logo on the screen to launch FreeFlight 6 USA. The interface displays the homescreen of FreeFlight 6 USA.

IMPORTANT: You must update the drone and controller before taking off.

7. Tap **FLY** and follow the onscreen instructions to update your ecosystem. FreeFlight 6 USA automatically begins with the controller update.
8. Skycontroller USA update: tap **CONTINUE**.

The **Preparing your controller** screen opens. An animation and a circular progress bar indicate that the update is under way. This operation takes a few minutes.

When the update is finished, the screen displays **Your controller is ready**.

9. Tap **CONTINUE** to launch the ANAFI USA update.
10. ANAFI USA update: tap **CONTINUE**.

The **Preparing your drone** screen opens. An animation and a circular progress bar indicate that the update is under way. This operation takes a few minutes.

When the update is complete, the screen displays **Your drone is ready**.

11. Tap **CONTINUE** to return to the FreeFlight 6 USA homescreen.

All systems are ready for flight.

Table of contents

Documentation changelog	2
Using this guide	3
Prerequisites	4
Table of contents	6
Foreword	8
ANAFI USA ecosystem	8
GPS	8
4K video formats	8
ANAFI USA smart batteries.....	9
Auto-RTH (return home)	9
User guide screenshots	9
DISCLAIMER	10
Technical specifications	12
Package contents	13
Presentation of ANAFI USA	14
Presentation of Skycontroller USA	16
LED status indicator color codes.....	17
Skycontroller USA Maintenance Mode	17
Maintenance mode via computer	17
Maintenance mode via external USB drive	18
FreeFlight 6 USA offline update via APK file	19
Transfer the APK file	19
Firmware updates	21
Skycontroller USA	21
ANAFI USA	21
Pairing ANAFI USA to a Skycontroller USA.....	21
Pre-flight checklist	22
Transport & handling.....	22
Equipment	22
Regulations.....	22
Flight conditions	22
Getting started	23
Taking off	24
Ground take-off.....	24
Hand launch.....	24
Deployment from a moving vehicle	25
Standard take-off from a moving vehicle.....	26
Flying	27
Optimal speeds	27
Optimal autonomy (flight time)	27
Optimal elongation (distance).....	27
Wi-Fi link optimization	28
Returning home: Smart RTH	29
Precise Home Setting	29
Low battery Smart RTH	29
Managing coordinates.....	29
Advanced RTH settings.....	31
Pilot RTH.....	31
Custom RTH.....	32
Landing	34
Recovery from a moving vehicle	34
Hand landing	34
Smart LiPo Battery	36
Battery removal.....	36
Battery installation	36
Battery charging	36
Battery care and safety	37
Battery state of health	38
Battery update	39
MicroSD card and media management .	40
Installing a microSD card.....	40
Retrieving photos and videos.....	40
Compatible microSD cards	41
Direct media retrieval (drone to computer).....	41
FreeFlight 6 USA Gallery.....	41
RTSP video stream sharing	44
Introducing FreeFlight 6 USA	46
Presentation of the HUD	46
Preferences	48
Controls.....	48
Presets.....	48
Thermal	49
Special	49
RTH function.....	50

Interface	50	Spiral	73
Safety.....	51	Epic.....	74
Camera	52	Piloting modes	75
Network.....	52	Manual flight	75
External antennas	54	Cameraman	75
Installing external antennas	54	Follow Me.....	76
Activating external antennas.....	54	Smartdronies.....	77
Reverting to the inbuilt antenna	54	How to prepare your map	79
Videos, Photos, and Panoramas	55	Save future flying area maps online for offline use..	79
Making videos	55	Import custom maps to FreeFlight 6 USA	79
Taking photos	56	Cursor on Target.....	84
Creating Panoramas	57	Overview	84
Gimbal tilt control	60	CoT HUD Overview.....	84
Zoom control.....	60	CoT Calibration	86
Camera Calibration.....	60	FLAT maps	87
Advanced image settings	63	CoT parameters.....	88
Lock AE	63	Screenshots	88
HDR.....	65	Map-based flying modes	89
Shutter speed (s)	65	Flight Plan.....	89
ISO value (ISO).....	66	Touch & Fly: Waypoint	91
White balance (WB).....	66	Touch & Fly: POI.....	92
Exposure value (EV).....	67	Maintenance and troubleshooting.....	93
Style.....	67	Changing propeller blades.....	93
ADJUSTMENT.....	68	Rebooting all systems.....	94
Thermal Imaging.....	69	Reinstalling FreeFlight 6 USA.....	94
Presentation of the Thermal HUD (post-processing)	69	ANAFI USA drone hard reset	94
Relative Thermal mode	70	Resetting the Skycontroller USA	94
Spot Thermal mode	71	ANAFI USA's smart battery hard reset	95
Thermal analyzer mode	72	Recover ANAFI USA	95
Cineshots (visible spectrum only)	73	Drone end of service life	95
360°	73	Frequently asked questions.....	96
Reveal.....	73	Appendix 1: Operational checklist	98

Foreword

ANAFI USA was designed and optimized to fly as is. Parrot strongly discourages the use of any add-on or accessory which could be mounted on, or attached to ANAFI USA (feet extensions, buoys, hulls, etc.). Accessories impose extra weight on the drone and its motors. Electronic accessories may also interfere with the drones' communications.

IMPORTANT: The maximum take-off mass (MTOM) of ANAFI USA is 644 g (1.42 lb). If you equip your drone with an accessory, it can drastically reduce its autonomy.

CAUTION: Do not alter the center of gravity of the drone.

Always transport ANAFI USA safely stored in its case. Always reposition the gimbal protective before storing the drone in its case.

ANAFI USA ecosystem

In the following pages, the word "*ecosystem*" refers to the drone (ANAFI USA), its controller (Skycontroller USA) and the FreeFlight 6 USA flying app.

GPS

ANAFI USA does not require a satellite synchronization, or fix, to take off (for example, GPS, GLONASS, Galileo). It can therefore be piloted indoors and through cluttered areas, stabilized by its onboard sensors.

However, automated and assisted flight modes require both ANAFI USA and Skycontroller USA synchronization to geocoordinate satellites.

Parrot recommends ANAFI USA pilots to always set up, start, and finish their automated and assisted flights from wide open areas, such as a sports field.

CAUTION: ANAFI USA flight stability performance may be impacted when you fly at night without a GPS fix. To reduce the possibility of drifts, Parrot recommends that you always wait for GPS synchronization before flying the drone at night. If GPS synchronization is not achieved with the drone on the ground, Parrot recommends that you leave the drone in hover flight until the GPS synchronizes.

If you continue to experience difficulties with flight stability, reduce the following values in the **Presets** menu:

- **Global reactivity**
- **Banked turn**
- **Inclination**
- **Vertical speed**
- **Rotation speed**

Refer to the "[Preferences / Presets](#)" section of this guide for more information.

4K video formats

4K video formats are professional grade media which may not be read natively by slower computers.

Furthermore, for software reasons, the stream broadcast by Skycontroller USA is better defined in the 1080p video mode than in 4K (or any photo mode), especially when using zoom. For this reason, Parrot recommends favoring default video settings (1080p, 30 fps) for direct observation.

4K video recording should be reserved for post-mission data exploitation.

ANAFI USA smart batteries

One smart battery comes preinstalled on the ANAFI USA. If you remove the battery, you must reinstall it in the same orientation. Ensure that you do not install the battery upside down as it can expose the battery and the drone to irreparable electrical damage.

IMPORTANT: The LEDs and power button face up in the correct orientation

NOTE: ANAFI USA and Skycontroller USA batteries enter a **Wintering mode** when not in use for ten consecutive days. You must wake the batteries up and charge them completely before you fly ANAFI USA for the first time.

Auto-RTH (return home)

If the battery charge level becomes low, ANAFI USA attempts to return to its most recent take-off point, at a minimal height over this take-off point. The default minimal height is 30 meters, but you can configure this height to between 20 and 30 meters through FreeFlight 6 USA.

IMPORTANT: This feature requires synchronization to GPS, GLONASS, or Galileo satellites.

Refer to the [“Coordinates and advanced RTH settings”](#) and [“PREFERENCES / Safety”](#) sections of this guide for further information on RTH.

User guide screenshots

For clarity and brevity, some screenshots in this guide, illustrating functions common to all the drones of the series, have been taken from earlier ANAFI series user guides. However, all screenshots associated with specific ANAFI USA functions have been updated.

DISCLAIMER

1. ANAFI USA IS NOT A TOY and must not be used or handled by persons under the age of 18 years.
2. BEFORE USING ANAFI USA:
 - (A) CAREFULLY READ the user manual and all information and documentation available on www.parrot.com. Documentation is subject to change and may be updated at any time and without prior notice (hereinafter referred to as "Parrot Documentation"). SPECIAL ATTENTION must be given to the paragraphs marked: **WARNING, CAUTION, IMPORTANT**.
 - (B) Ensure that the complete drone ecosystem is up-to-date. Parrot regularly releases firmware updates for:
 - FreeFlight 6 USA
 - ANAFI USA
 - Smart Battery
 - Skycontroller USA

Updates add new features, and improve stability, and performance of the complete system. Updates are mandatory and must be systematically performed prior to any flight to ensure maximum performance and safety. Flying with a non-up-to-date system may impact warranty rights and jeopardize safety requirements.

- (C) ENSURE YOU ARE AWARE OF THE REGULATIONS APPLICABLE TO THE USE OF DRONES AND THEIR ACCESSORIES (hereinafter referred to as "Applicable Regulations");
 - (D) REMEMBER that ANAFI USA may expose others and yourself to EQUIPMENT DAMAGE, PERSONAL INJURY, OR BOTH, which could result in serious harm or death.
3. All Parrot drones must always be used with genuine Parrot smart batteries. Non-genuine batteries are forbidden, and their use will void the warranty, and impact safety requirements.
4. All Parrot drone systems include charger(s). These are the only recommended chargers to use to charge your Parrot drones Smart Battery and Skycontroller USA. Other generic USB chargers may be used provided that they are certified according to the country of use and have the applicable rating/specification. Performance and warranty are only guaranteed when using a genuine charger included in the Parrot drone system. Parrot takes no responsibility (warranty or safety) for third party USB chargers being used with a Parrot system.
5. Videos and photos promoted and advertised by Parrot Drones SAS and its affiliates have been made by and with experienced professionals and drone pilots. IN CASE OF DOUBT RELATING TO THE USE OF YOUR ANAFI USA DRONE AND ITS ACCESSORIES, ALWAYS REFER TO THE MOST RECENT VERSION OF THE PARROT DOCUMENTATION.
6. TO THE MAXIMUM EXTENT PERMITTED BY APPLICABLE LAW, PARROT DRONES SAS, ITS SUBSIDIARIES, AND THEIR RESPECTIVE DISTRIBUTORS AND RETAILERS WILL NOT BE LIABLE FOR ANY DAMAGES ARISING FROM, OR IN CONNECTION WITH NON-COMPLIANCE OF PARROT DOCUMENTATION OR THE APPLICABLE REGULATIONS BY YOURSELF OR ANY PERSON USING YOUR ANAFI USA.

IMPORTANT: Parrot strongly recommends that you regularly refer to the [Release Notes ANAFI USA](#) available on the Parrot website, to ensure that you have the latest firmware versions of the drone, controller, and application.

If you are an offline user, contact your local Parrot Partner or Parrot contact to obtain the .apk file to perform an offline system update.

Refer to the “[FreeFlight 6 USA offline update via APK file](#)” chapter for more information.

Technical specifications

DRONE

- Size folded: 252 x 104 x 84 mm (9.9 x 4.1 x 3.3")
- Size unfolded: 282 x 373 x 84 mm (11.1 x 14.7 x 3.2")
- Mass: 501 g (1.10 lb)
- Maximum take-off mass (MTOM): 644 g (1.42 lb)
- Ready to fly in 55 seconds
- Maximum transmission range with the enclosed Parrot Skycontroller USA:
 - Wi-Fi: 4 km (2.49 mi)
- Maximum flight time: 32 minutes
- Maximum horizontal speed: 14.7 m/s (32.8 MPH)
- Maximum ascent speed:
 - Standard version: 4 m/s (8.9 MPH)
 - Software unlocked version: 6 m/s (13.4 MPH)
- Maximum descent speed: 3 m/s (6.7 MPH)
- Maximum wind resistance:
 - During flight: 14.7 m/s (32.8 MPH)
 - During take-off and landing: 14.7 m/s (32.8 MPH)
- Maximum propeller speed: 11,000 RPM
- Sound power level: 84 dBA
- Service ceiling: 5,000 m above MSL (Mean Sea Level)
- User defined geofencing
- Operating temperature: -36 °C to 50 °C (-33 °F to 122 °F)
- No take-off temperature limitation - if battery temperature is maintained between 5 °C and 70 °C (41 °F to 158 °F)
- IP53: Rain and dust resistant
- Maximum static thrust: 12.92 N
- Thrust to weight ratio: 2.63
- No NFZ (no-fly zone) limitation
- MicroSD card slot
- Takes off from / lands in the hand of the operator
- Indoor flight

SENSORS

- Satellite navigation: GPS, GLONASS, & Galileo
- Barometer and magnetometer
- Vertical camera and ultrasonic
- 2 x 6-axis inertial measurement units
- 2 x 3-axis accelerometers
- 2 x 3-axis gyroscopes

CYBERSECURITY

- Zero data shared without user consent
- TAA & NDAA compliant
- Blue sUAS program approved
- Manage your data privately between drone and device OR share anonymous data on secured European servers
- SD card AES-XTS encryption with a 512-bit key
- Digitally signed firmware
- Transparency & Bug bounty continuous security check

EO IMAGE CHAIN

- 2 Sensors: 1/2.4"
- Digital zoom: 32x
- Electronic shutter speed: 1 s to 1/10,000 s
- ISO range: 100-3,200

- Video resolution: 4k/FHD/HD
- Video format: MP4 (H.264)
- Photo resolution:
 - Wide: 21 MP (84° HFOV);
 - Rectilinear: up to 16 MP (up to 75.5° HFOV)
- Photo formats: JPEG, DNG (Digital Negative raw)

IR IMAGE CHAIN

Sensor: FLIR BOSON

- 320x256 resolution
- -40 °C to 150 °C (-40 °F to 302 °F) temperature range
- Thermal sensitivity: <60 mK
- Measured IR wavelength range: 7.5 to 13 micrometers
- Photo format: JPEG
- Video format: MP4 (H.264)
- Video recording resolution: 1280x720, 9 fps

IMAGE STABILIZATION

- 3-camera IR/EO stabilized gimbal:
 - Hybrid: 3-axis
 - Mechanical: 2-axis roll / pitch
 - Electronics (EIS): 3-axis yaw / roll / pitch
- Controllable gimbal tilt range: -90° to +90°

FAST-CHARGING SMART BATTERY

- Type: High density LiPo (197 Wh/kg)
- Capacity: 3,400 mAh
- Voltage (nominal): 11.55 V (3 x 3.85 V cells)
- Battery life: 32 minutes
- Charging port: USB-C
- Charges fully in 2 h with a USB-PD (Power Delivery) charger – not included in the pack
- Charges fully in 3 h 20 mins with the fast-charging port of the provided charger
- Mass: 199 g (0.44 lb)
- Maximum charging power: 30 W

PARROT SKYCONTROLLER USA

- Size: 313 x 208 x 72 mm (12.3 x 8.2 x 2.8")
- Mass: 1,140 g (2.51 lb)
- Transmission system: Wi-Fi 802.11a/b/g/n (Wi-Fi beacon)
- Operating frequencies: 2.4 GHz, UNII-1, & UNII-3
- Direct video stream resolution: 720p
- Battery capacity: 5,000 mAh
- Battery voltage (nominal): 7.2 V
- Battery life: Charges fully in 2 h for 4 h 30 mins of use based on a Samsung Galaxy tablet
- USB ports: USB-C (charging), USB-A (connecting)
- Ethernet port
- IP53: rain and dust resistant

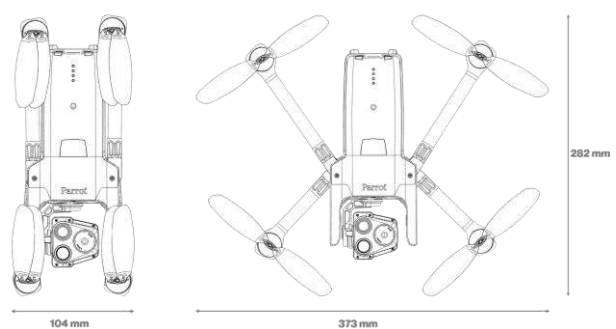
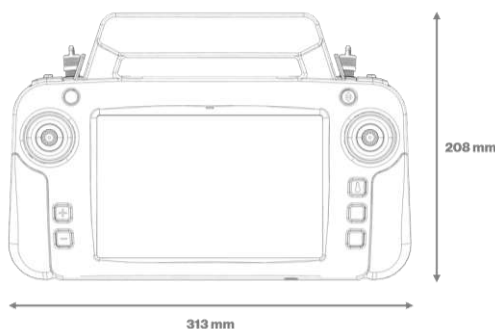

Package contents

Your ANAFI USA package contains:

- 1 ANAFI USA drone
- 1 Skycontroller USA with 8-inch display
- 3 smart batteries (2 + 1 preinstalled on ANAFI USA)
- 1 multi-port fast USB charger
- 1 Skycontroller USA charger
- 1 additional set of propeller blades
- 3 USB-A/USB-C cables
- 1 gimbal protection cover
- A Flight Safety Guide
- 1 hard case



Presentation of ANAFI USA

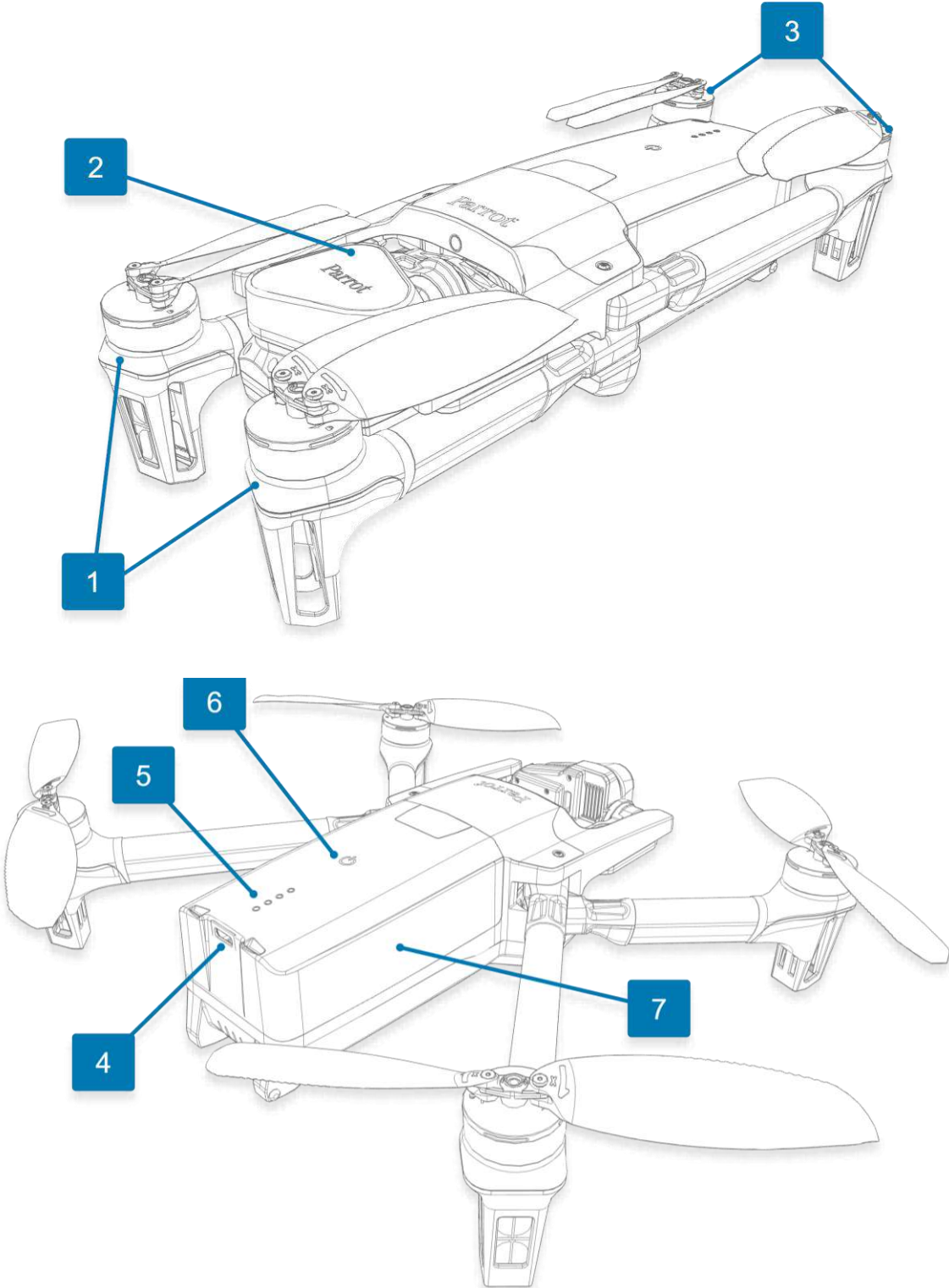

- 1. Front foldable arms and propellers
- 2. Gimbal protective cover
- 3. Rear foldable arms and propellers
- 4. USB-C charging port
- 5. Charge level LED indicators
- 6.  Power button
- 7. Smart battery

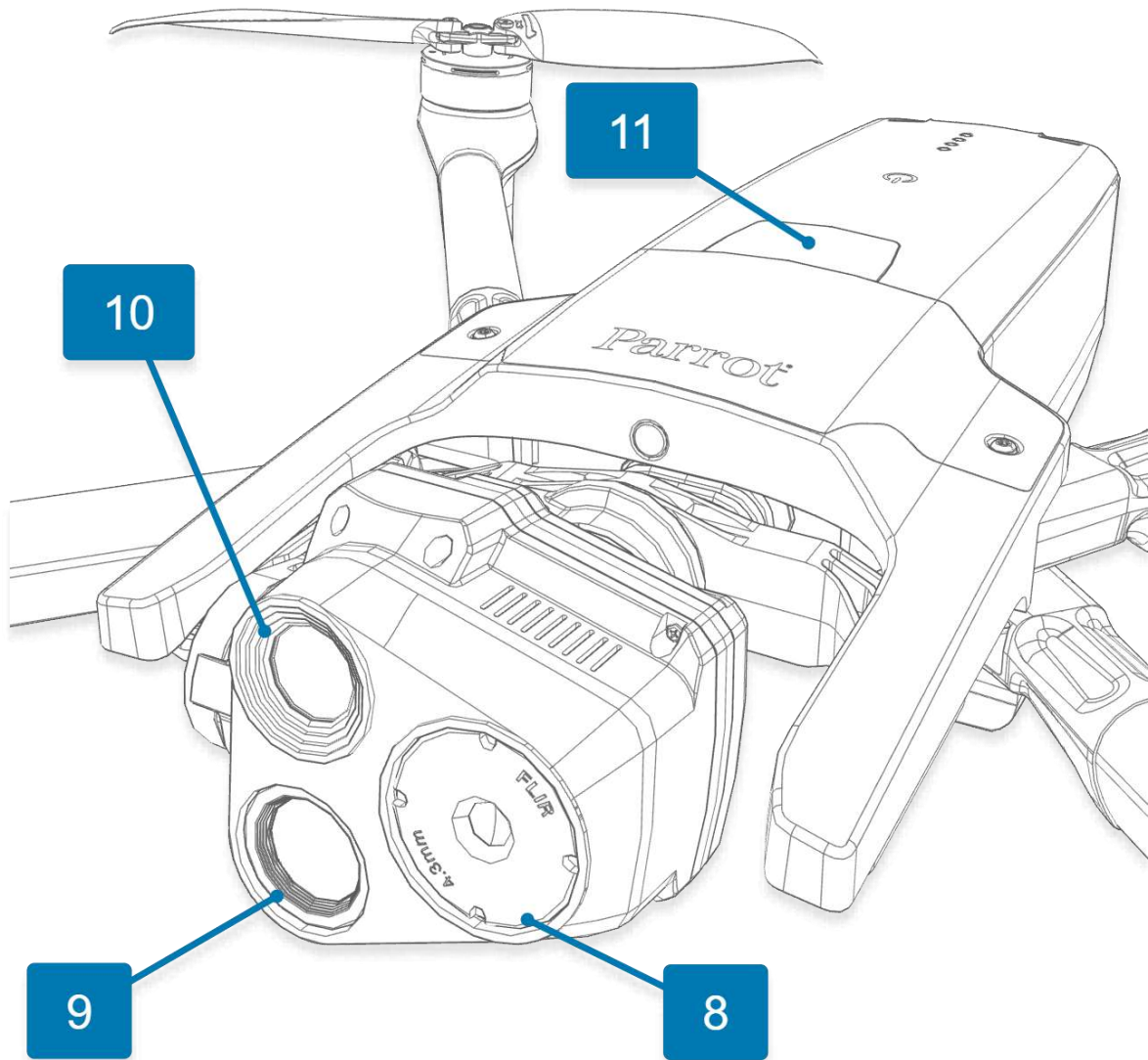

- 8. Thermographic camera
- 9. 21 MP telephoto camera

- 10. 21 MP wide angle camera
- 11. Battery extraction button

Presentation of Skycontroller USA

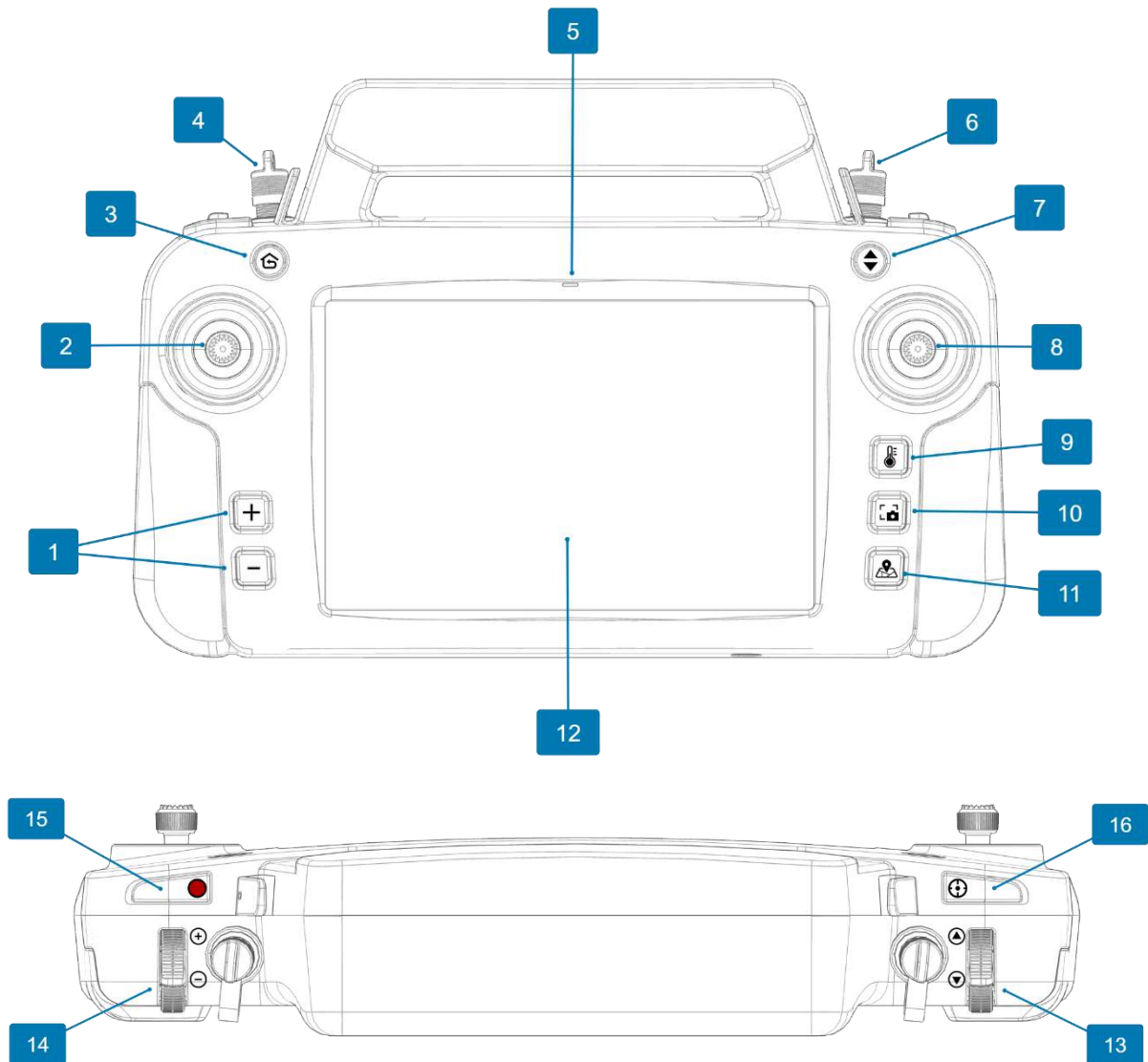

- | | |
|-------------------------------------|-------------------------------------|
| 1. +/- EV | 9. Visible IR |
| 2. Left joystick | 10. Screenshot |
| 3. RTH (Return to Home) button | 11. Video stream/Map view toggle |
| 4. Left external antenna connector | 12. Integrated tablet |
| 5. Status LED | 13. Gimbal tilt trigger |
| 6. Right external antenna connector | 14. Zoom trigger |
| 7. Take-off/Land button | 15. Shutter & Start/Stop recording |
| 8. Right joystick | 16. Optics reset |







WARNING: If you press RTH, Take-Off/Land, and Shutter simultaneously, the EMERGENCY MODE on ANAFI USA activates immediately. EMERGENCY MODE instantly cuts power to all motors on ANAFI USA, which causes the drone to fall from the sky.

Refer to the "[Flying](#)" section for more information.

LED status indicator color codes

When the Skycontroller USA is powered on, its status LED indicator provides an instant visual indication:

LED colors and behavior

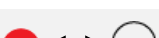
	Steady green	Skycontroller USA Maintenance Mode
	Flashing green	Skycontroller USA update in progress
	Alternating light blue/dark blue	Connecting to ANAFI USA
	Flashing light blue	No drone configured or incorrect WPA key
	Steady dark blue	Connected to ANAFI USA
	Alternating purple/dark blue	Autonomous flight in progress
	Alternating red/any color	Low battery alert (ANAFI USA, Skycontroller USA, or both)

Skycontroller USA Maintenance Mode

You must set the Skycontroller USA to Maintenance Mode to access the tablet's data (screenshots, downloaded media), and to install maps (batches of PNG images, compressed together in a ZIP archive). Maintenance mode is also used to update FreeFlight 6 USA via PC, or a USB external drive.

Equipment required:

- a laptop or desktop computer equipped with a USB-A port,
- a USB-A to USB-C cable.

Maintenance mode via computer

To activate Maintenance Mode via PC:

1. Power the Skycontroller USA on
2. Connect the controller's USB-C port to the computer's USB-A port.
3. Press and hold the  **RTH** button on Skycontroller USA, then press its **Reset** button with the tip of a paperclip, or a pen.

The LED of the Skycontroller USA turns light blue, then, after approximately three seconds, it turns green.

4. When the LED is green, release the  **RTH** button.

A pop-up appears on the screen of the Skycontroller USA, asking you to **Allow access to tablet data?**

5. Tap **Allow**

After a few seconds, the internal memory of the Skycontroller USA tablet appears on the computer screen.

6. Click the down arrow beside **This PC**, then click the down arrow beside **Galaxy Tab A (8.0", 2019)**, then click **Tablet** to show the tablets folders.

To exit maintenance mode, press the  **RTH button**.

Skycontroller USA reboots in normal (non-maintenance) mode.

If the internal memory of the tablet is not detected by the computer during the procedure, verify that the Skycontroller USA and the computer are properly connected.

If the controller and the computer are properly connected and the problem persists, verify that the tablet allows you to transfer files by following this procedure:

- A. Disconnect the Skycontroller USA from the computer.
- B. On the tablet home screen, swipe down from the top of the screen to open the notification panel.
- C. Tap **Android System – Connected to a USB accessory**
- D. The **USB settings** screen opens.
- E. Select **Transferring files / Android Auto**

Maintenance mode via external USB drive

1. Insert an external USB drive into the USB port A on the back of Skycontroller USA.

NOTE: the external USB drive must be formatted in FAT32.

2. Press and hold the  **RTH button** of the Skycontroller USA, then press its **Reset** button with the tip of a paperclip, or a pen.

The LED of the Skycontroller USA turns light blue, then, after approximately three seconds, it turns green.

3. When the LED is green, release the  **RTH button**.

The notification panel shows that the external USB drive is now accessible on the tablet.

To exit the maintenance mode, press the  **RTH button**.

The Skycontroller USA reboots in normal (non-maintenance) mode.

FreeFlight 6 USA offline update via APK file

You can update FreeFlight 6 USA via computer, or via a USB external drive. Both procedures require you to activate the maintenance mode on Skycontroller USA.

You will need:

- A USB-A to USB-C cable, or an external USB drive
- The FreeFlight 6 USA APK file

NOTE: You can also download FreeFlight 6 USA from the Play Store, or alternatively, Parrot or your Parrot reseller can provide you with it.

Transfer the APK file

Via your computer

Reconnect the Skycontroller USA to the computer. Create a new folder on the internal memory of the Skycontroller USA tablet. Parrot recommends that you name this folder FreeFlight 6 USA. Transfer the FreeFlight 6 USA APK file to the **FreeFlight 6 USA** folder that you just created on the tablet's internal memory.

Disconnect the Skycontroller USA from the computer.

Via an external USB drive

Insert your external USB drive into your computer's USB-A port. Create a new folder on the external drive. Parrot recommends that you name this folder FreeFlight 6 USA. Transfer the FreeFlight 6 USA APK file to the **FreeFlight 6 USA** folder that you just created on the external drive.

Close the external drive window on your computer, and safely eject the external USB drive, and then insert it into the USB-A port on your Skycontroller USA.

FreeFlight 6 USA update application on the Skycontroller USA

On Skycontroller USA, swipe up to open the tablet menu. Tap the **Samsung** tile, then tap **My Files**.

Scroll down in the **Categories** section, and tap the **Installation files** tab.

NOTE: If you are going to update FreeFlight 6 USA via an external USB drive, the APK file appears in the **FreeFlight 6 USA** folder that you created, under the **USB Storage** tab, instead of the **Installation files** tab.

Tap on the **FreeFlight 6 USA** folder, then tap the **FreeFlight6Usa-release.apk** file to install, or update FreeFlight 6 USA.

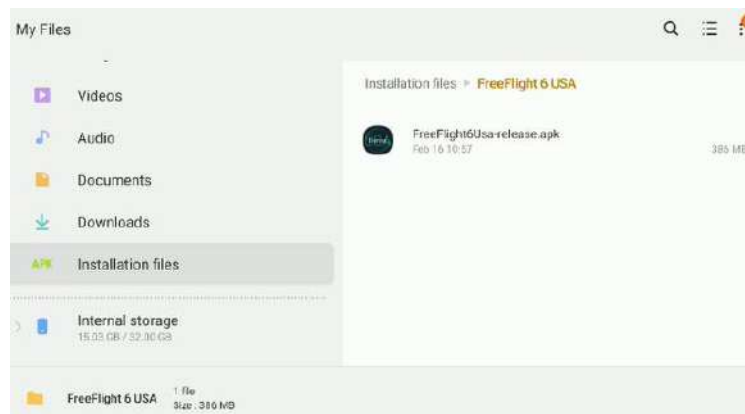

You must enable the tablet to install third-party applications. When you tap on the APK file, a popup appears which allows you to install unknown apps.

Tap **Settings**.

The **Install unknown apps** page opens. Toggle the switch for **Allow from this source** to authorize the installation of third-party applications.



Tap **<Install unknown apps** to return to the previous screen.

NOTE: Alternatively, you can swipe up on the tablet screen to access the menu, then navigate to **Settings > Apps > My Files > Install unknown apps** to toggle the switch **Allow from this source**.

A window opens asking you if you want to install, or update FreeFlight 6 USA. Tap **Install**.



A second window opens to notify you that the FreeFlight 6 USA application is installed. Tap **Done**.

When you open the FreeFlight 6 USA application, a popup appears asking for authorization for the application to access Skycontroller UA. Select **Always open FreeFlight 6 USA when Skycontroller USA is connected**, then tap **OK**.

FreeFlight 6 USA is now up to date.

Firmware updates

Skycontroller USA

On the FreeFlight 6 USA home screen, tap the **Controller** button.

The Skycontroller USA screen opens, it displays the:

- **Serial number**
- **Hardware**
- **Software version**

NOTE: If your Skycontroller USA has the most up to date **Software version**, it displays **latest version** (in green font color) and the version number.

If your **Software version** is not up to date, tap **Update** and wait for the update procedure to complete.

Skycontroller USA is now up to date.

A popup appears asking for authorization for the application to access Skycontroller UA. Select **Always open FreeFlight 6 USA when Skycontroller USA is connected**, then tap **OK**.

ANAFI USA

Power on Parrot ANAFI USA and make sure it is properly connected to Skycontroller USA. On the FreeFlight 6 USA home screen, tap the **Drone** button.

The ANAFI USA screen opens, it displays the:

- | | |
|-----------------------------------|--------------------------------|
| - Product type | - Number of flights |
| - Software version | - Last flight duration |
| - Hardware version | - Total flight duration |
| - Serial number | - Last motor error |
| - Maximum battery capacity | - Security features |

NOTE: If your ANAFI USA has the most up to date **Software version**, it displays **latest version** (in green font color) and the version number.

If your **Software version** is not up to date, tap **Update** and wait for the update procedure to complete after the drone has rebooted.

Parrot ANAFI USA is now up to date.

Pairing ANAFI USA to a Skycontroller USA

To pair a drone and a controller for the first time, and to restore the lost pairing:

1. Verify that a compatible microSD card is inserted into ANAFI USA.
2. Power ANAFI USA on.
3. Power the Skycontroller USA on.
4. Connect the drone and the controller with a USB cable (USB-A connection to the controller, USB-C connection to the drone).
5. The LED of the Skycontroller USA briefly flashes green to indicate it acknowledges ANAFI USA.

Pre-flight checklist

Transport & handling

- Always transport ANAFI USA in its hard case, safely positioned, with the gimbal's protection cover on.
- Always transport the Skycontroller USA safely in the relevant location in the hard case.
- Protect the battery from temperature extremes, both low and high. Try to keep the battery as close as possible to ambient temperatures.
- Always handle the ANAFI USA with care. Do not apply pressure to the drone and generally avoid touching the sensitive camera and gimbal.
- Always keep the hard case with the drone and battery in dry places.

Equipment

- Ensure that you download the latest version of FreeFlight 6 USA and that both your Skycontroller USA and your ANAFI USA are up to date with the latest versions of firmware.

IMPORTANT: Updates are mandatory and must be performed systematically prior to any flight to ensure maximum performance and safety.

- Ensure that you insert a microSD card with enough free memory space into the drone.
- Ensure that you unfold all four foldable arms of the drone.
- Ensure that the drone's propellers are clean, intact, and unobstructed.
- Ensure that both ANAFI USA's and Skycontroller USA's batteries are fully charged.
- Ensure that you always use genuine Parrot smart batteries. Non-genuine batteries are forbidden, and their use will void the warranty and impact safety requirements.
- Ensure that the drone's battery is securely installed on the drone's body.
- Ensure that the drone's gimbal protective cover is removed.
- Ensure that the drone's lenses are clean. If the lenses require cleaning, clean them before you press  **Power** on the drone. Hold the gimbal between two fingers so that you do not apply pressure to the mechanism. Gently wipe the lenses with a microfiber cloth.

Regulations

- Ensure that drone use is permitted where you intend to fly.
- Check for potential restrictions regarding the use of Wi-Fi frequencies in the area where you intend to fly.

Flight conditions

- Ensure that the flying zone is safe and clear.
- Do not fly ANAFI USA over urban areas or over restricted airspaces such as airports, train stations, power plants, national reserves, etc.
- Check the weather. Do not fly ANAFI USA in the fog, or in wind exceeding 14.7 m/s (32.8 MPH).
- Due to the operating mode of its vertical camera and ultrasonic sensor, Parrot recommends you do not fly ANAFI USA less than 10 m (30 ft) over water, or other reflective surfaces such as mirrors, glass, etc.



ANAFI USA has been designed to assist first responders. It has no inbuilt no-fly zone limitations, it can fly in the rain, and at night.

WARNING: Always deploy ANAFI USA responsibly.

Getting started

1. Charge the batteries using the enclosed USB-A to USB-C cable and charger. Refer to the [“Battery charging”](#) section of this guide for more information.

Parrot recommends you always fully charge all batteries before flying ANAFI USA.



2. Ensure that your flying zone is safe and clear.
3. Unfold the arms.
4. To start the drone, place it on a flat horizontal surface and press  **Power**.
5. Power on the Skycontroller USA by pressing the  **Power** button.
6. Launch FreeFlight 6 USA, which connects ANAFI USA to Skycontroller USA.
7. Systematically check for FreeFlight 6 USA, Skycontroller USA, and ANAFI USA software updates to ensure maximum performance and safety.

IMPORTANT: Parrot strongly recommends that you regularly refer to the [Release Notes ANAFI USA](#) available on the Parrot website, to ensure that you have the latest versions of the drone and controller firmware, and FreeFlight 6 USA App. If you are an offline user, you must contact your local Parrot Partner or Parrot Contact to obtain the .apk file to perform an offline system update. Refer to the [“FreeFlight 6 USA offline update via APK file”](#) chapter for more information.

8. Calibrate your ANAFI USA, your Skycontroller USA, or both, if required. Follow the instructions on the screen.
9. Ensure that your flying zone is still safe and clear, and that no person or animal has approached or is approaching ANAFI USA.
10. Stay at least 2 m (6 ft) from the drone, press  **Take-off/Land** to start the flight operation.

Taking off

Ground take-off

1. Position ANAFI USA on a flat, even, and clear surface.
2. Press  **Power** on ANAFI USA
3. Move at least 2 m (6 ft) away from ANAFI USA
4. Check that the surroundings of the drone are absolutely clear.
5. Press  **Take-off/Land** on your Skycontroller USA, or tap the green **TAKE-OFF** box, on the screen.

ANAFI USA takes off and stabilizes at 1 m (3 ft) from the ground, waiting for commands from the pilot.

Hand launch

A hand launch procedure is more dangerous than a ground take-off. Be especially careful with the hand launch feature. It requires complete focus. Do not become distracted and stay aware of your surroundings.

WARNING: DANGEROUS MANEUVER. RISK OF BODILY INJURY AND DAMAGE TO THE DRONE IN CASE INSTRUCTIONS ARE NOT FOLLOWED. LACERATION HAZARD. Do not touch the propeller blades during flight. Propeller blades can cause deep cuts if your fingers, or other body parts, come into contact with them. Keep the drone as far away from your face as possible. PARROT STRONGLY RECOMMENDS THAT YOU DO NOT PERFORM A HAND LAUNCH PROCEDURE INDOORS, DUE TO LOW STABILITY, AND INCREASED RISK.

Parrot recommends that you work as a team of two people: one person to perform the take-off procedure, while the other person focuses on flying the drone. This eases the pressure of having to multi-task.

Pay attention to the wind direction and speed. Do not face the wind. Keep yourself at a safe distance from the drone considering the possibility of drifting with the wind.

When you first open FreeFlight 6 USA, a hand launch tutorial reminds you of the following procedure. You can activate hand launch from this tutorial page.

You can also activate the hand launch option from **PREFERENCES > Interface** of FreeFlight 6 USA (refer to the "[PREFERENCES / Interface](#)" section of this guide for more information).

1. Press  **Power** to power on ANAFI USA.
2. Position the drone on your flat, open hand.

On the screen, the green **TAKE-OFF** box is replaced by a blue **HAND LAUNCH** box.

3. Press  **Take-off/land** on Skycontroller USA or tap the blue **HAND LAUNCH** box on the screen.



The drone's propellers start to rotate slowly, and the screen displays a hand-launch animation.

4. Wait until the propellers' rotation speed stabilizes, then briefly and rapidly lift ANAFI USA up and forward with your open hand.

ANAFI USA becomes airborne. It stabilizes and waits for commands from the pilot.

Only perform a hand launch procedure when there is no other launch alternative.

CAUTION: In environments with sand, use hand launch, instead of ground take-off to prevent sand from penetrating the motors.

Deployment from a moving vehicle

Points of attention for the deployment of the drone from a moving vehicle

- Whenever possible, mobilize two operators for the deployment of the drone from a moving vehicle.
- If only one operator is available, favor the **Take-off from a moving vehicle** procedure.
- If required by FreeFlight 6 USA and whenever possible, perform, the magnetometer calibration of the drone far away from any metallic mass.
- When preparing a deployment from a ship or an armored vehicle, always keep your powered-on drone in your hand, away from the floor of the ship or the roof of the vehicle.
- The GPS fix is not mandatory to deploy the drone from a moving vehicle, but it is always recommended.
- In the unlikely situation where the drone becomes disoriented after a launch or a take-off from a moving vehicle (uncontrolled rotation), quickly and firmly take back the commands of the drone in rotation and elevation (left joystick laterally and upward in default mode) to retrieve flight control.

Hand launch from a moving vehicle

Parrot recommends mobilizing two operators for this procedure: one operator launches the drone while another operator controls the drone with both joysticks of the Skycontroller USA.

WARNING: Be especially careful when hand launching ANAFI USA from a moving vehicle. It requires complete focus. Do not allow yourself to become distracted and stay aware of your surroundings.

Activate the hand launch option from **PREFERENCES > Interface** of FreeFlight 6 USA (refer to the [“PREFERENCES / Interface”](#) section of this guide for more information).

Power ANAFI USA on and position the drone in the palm of the operator’s hand. On the screen, the green **TAKE OFF** box has been replaced by a blue **HAND LAUNCH** box.

WARNING: Stabilize the speed and direction of the vehicle as much as possible. The maximum vehicle speed for this feature is 30 km/h in a straight line. Do not operate this feature in wind or downwind.

Press **◆ Take-off/Land** on Skycontroller USA, or activate the launch directly from the blue **HAND LAUNCH** box on the screen. Motors and propellers start rotating slowly and an animation on screen confirms the activation of a hand launch.

When the propellers’ speed has stabilized:

1. Briefly and rapidly lift ANAFI USA upward with your open hand, and toward a direction free of all obstacles.
2. Immediately push the left joystick of the Skycontroller USA (elevation) upward (default control mode) to increase the drone’s altitude.
3. If possible, monitor the behavior of the hovering drone for 10 to 30 seconds before beginning the mission, to confirm the convergence of all sensors’ estimates.

Standard take-off from a moving vehicle

WARNING: Be especially careful when performing a standard take-off from a moving vehicle. It requires complete focus. Do not allow yourself to become distracted and stay aware of your surroundings.

Power ANAFI USA on and position the drone in the palm of your hand.

WARNING: Stabilize the speed and direction of the vehicle as much as possible. The maximum vehicle speed for this feature is 30 km/h in a straight line. Do not operate this feature in wind or downwind.

1. Press **◆ Take-off/Land** on Skycontroller USA, or activate the take-off directly from the green "TAKE OFF" box on the screen;
2. Immediately push the left joystick of the Skycontroller USA (elevation) upward (default control mode) to increase the drone's altitude.
3. If possible, monitor the behavior of the hovering drone for 10 to 30 seconds before beginning the flight operation, to confirm the convergence of all sensors' estimates.

Deactivate the hand launch option from **PREFERENCES > Interface** of FreeFlight 6 USA. Refer to the "[PREFERENCES / Interface](#)" section of this guide for more information.

Flying

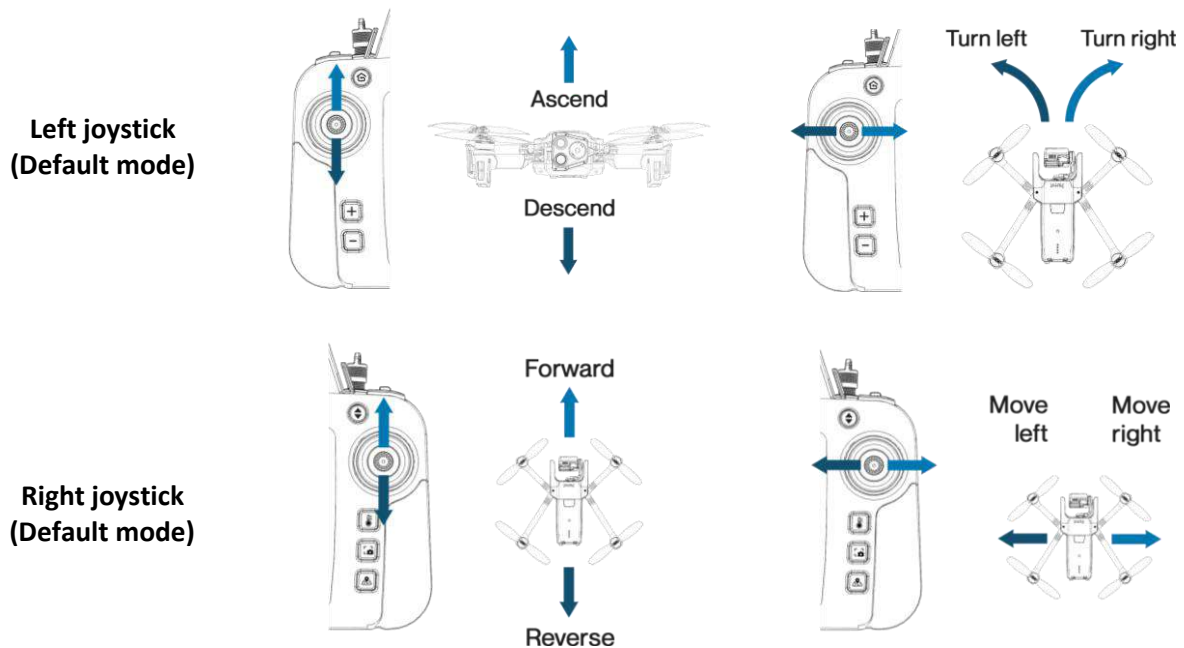

You can modify ANAFI USA's controls through the **PREFERENCES** menu of FreeFlight 6 USA. Refer to the "[PREFERENCES / Controls](#)" section of this guide for more information.

As a safeguard measure, ANAFI USA is programmed to instantly cut its motors in case of impact on one of its propeller blades: always control your drone carefully.

WARNING: ANAFI USA features an EMERGENCY MODE. If you activate EMERGENCY MODE in flight, all motors immediately cut out and instantly forces the drone to crash to the ground. The EMERGENCY MODE meets the regulatory requirement for Specific category flights in French national standard scenarios S1 & S3. The use of this mode is at the user's responsibility.

To activate EMERGENCY MODE, press the following buttons on Skycontroller USA simultaneously:

-  RTH
-  Take-off/Land
-  Shutter

Optimal speeds

Refer to the "[PREFERENCES / Presets](#)" section of this guide for more information about the settings of the flight behavior of the drone. Among these settings, two precise values enable you to optimize either ANAFI USA's flight time, or the distance it can cover on a single battery.

Optimal autonomy (flight time)

At full throttle, a 9° inclination angle (pitch) enables ANAFI USA to maintain a 6 m/s horizontal speed. This speed, maintained on a full flight, guarantees the longest autonomy, for the drone.

Optimal elongation (distance)

At full throttle, a 22° inclination angle (pitch) enables ANAFI USA to maintain a 12 m/s horizontal speed. This speed, maintained on a full flight, enables the drone to cover the longest distance, on a single battery.

Wi-Fi link optimization

ANAFI USA's ecosystem is designed to optimize, in real time, the Wi-Fi communications between the Skycontroller USA and the drone. By default, the ecosystem automatically selects the most efficient Wi-Fi channel available.

In urban environments, 5 GHz Wi-Fi channels typically suffer less interference than 2.4 GHz channels. Refer to the "[PREFERENCES / Network](#)" section of this guide for more information on Wi-Fi channel management and allowing automatic switching to 5 GHz channels.





To maintain an optimal Wi-Fi connection between the remote control and the drone, remember to keep a clear line of sight between them, and always direct the antennas of the Skycontroller USA toward ANAFI USA.

Several FreeFlight 6 USA alerts enable you to react before a complete loss of Wi-Fi link. If the connection breaks down, ANAFI USA automatically initiates a RTH procedure. By default, the drone flies upward to 30m and starts flying toward its take-off position.

In most cases, this behavior enables a very fast recovery of the Wi-Fi link between the remote control and the drone, and pilots regain full control of the flight.

Refer to the "[Returning home](#)", "[Smart RTH](#)", "[Coordinates and advanced RTH settings](#)" and "[PREFERENCES / Safety](#)" sections of this guide for more information on RTH configuration.

Refer to the following table for FreeFlight 6 USA Wi-Fi statuses and the corresponding icons.

	The Wi-Fi link is perfect.
	The Wi-Fi link is good.
	The Wi-Fi link is poor.
	The Wi-Fi link is about to lose connection.

WARNING: never fly your drone out of your direct line of sight unless special authorization has been granted.

Returning home: Smart RTH

To return ANAFI USA to its take-off position, press  **RTH** on your Skycontroller USA, or tap the  **Return to Home** on your screen.

ANAFI USA rises to 30 meters higher than the take-off point height and returns to hover over its take-off position.

NOTE: The default setting is 30 meters over the take-off point, but you can configure the height to between 20 and 100 meters through FreeFlight 6 USA.

Refer to the [“PREFERENCES / Safety”](#) section of this guide for more information on RTH configuration.

Precise Home Setting

When flight conditions are optimal at take-off, ANAFI USA can set a set a **PRECISE HOME** with its vertical camera. In that case, a pop-up on the screen of FreeFlight 6 USA confirms a precise home has been set, and the home icon of the minimap turns green.

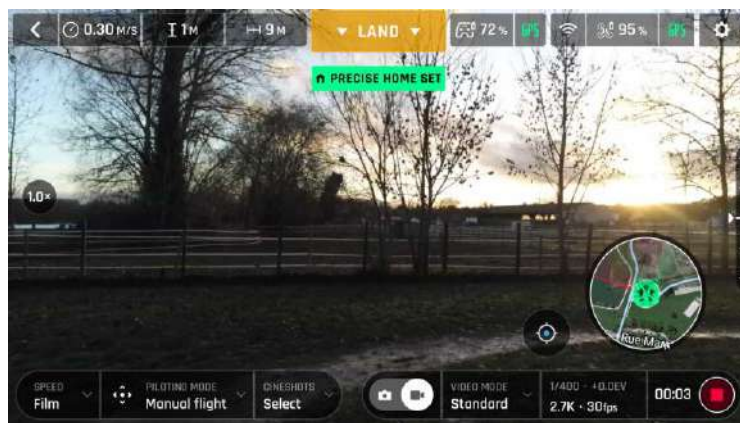

“Precise Home Set” pop-up

Low battery Smart RTH

ANAFI USA features a Smart RTH capability which considers its altitude and distance from its take-off point. The drone computes in real time, the battery power it requires to return home, or to the pilot, or to a custom location (refer to the [“PREFERENCES / Safety”](#) section of this guide for more information).

When the battery charge level becomes low, FreeFlight 6 USA alerts you that it will enter Smart RTH mode.

If you feel confident you can return ANAFI USA to its take-off point, or if you wish to land it at a different location, you can cancel the Smart RTH directly from the alert pop-up.

Managing coordinates

ANAFI USA features a fly-by-coordinates function which allows you to instantly display, reuse and share any coordinates in the surroundings of your drone, or the GPS position of your drone itself. This is especially useful to precisely locate any point of interest or person ANAFI USA has detected.

This section explains how to access coordinates on the FreeFlight 6 USA app map, in flight or to prepare a flight.

By default, coordinates are displayed on the FreeFlight 6 USA app map. They can be set as:

- latitude and longitude (LATLNG: default value)
- MGRS (Military Grid Reference System: NATO's geocoordinate standard)
- UTM (Universal Transverse Mercator)
- DMS (degree, minute, second – of arc)

Refer to the “[PREFERENCES / Interface / Coordinates system](#)” section of this guide for information on selecting a coordinates system.

In the following example, the coordinates system is set as DMS. The drone is offline, and the Skycontroller USA is connected to local Wi-Fi.



Offline FreeFlight 6 USA interface: tap minimap to open full screen

Tap **FLY** from the FreeFlight 6 USA homescreen.

Tap the minimap on the bottom center of the offline interface to access the full screen map.

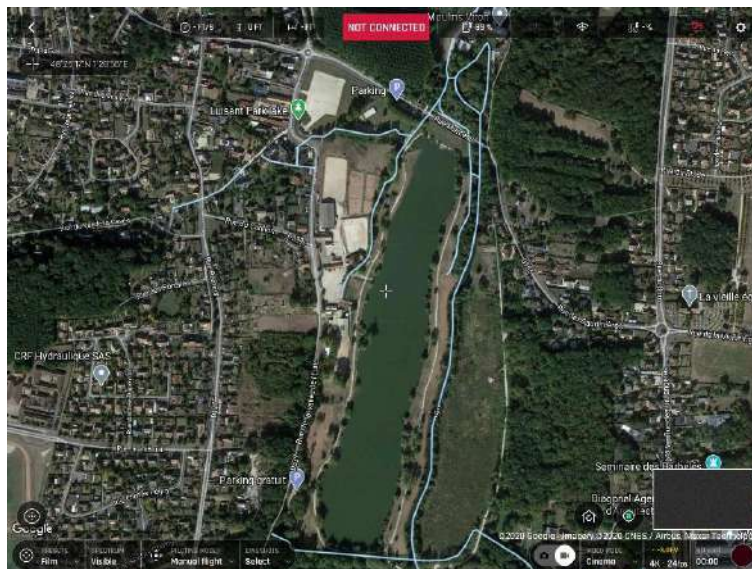

Reticle (crosshair) at the center of the screen, coordinates top left

By default, **Reticle** (crosshair at the center of the screen) coordinates are displayed on the top left of

the screen.

Move the map around and zoom in to pinpoint any spot, then tap the coordinates box to activate coordinates options.

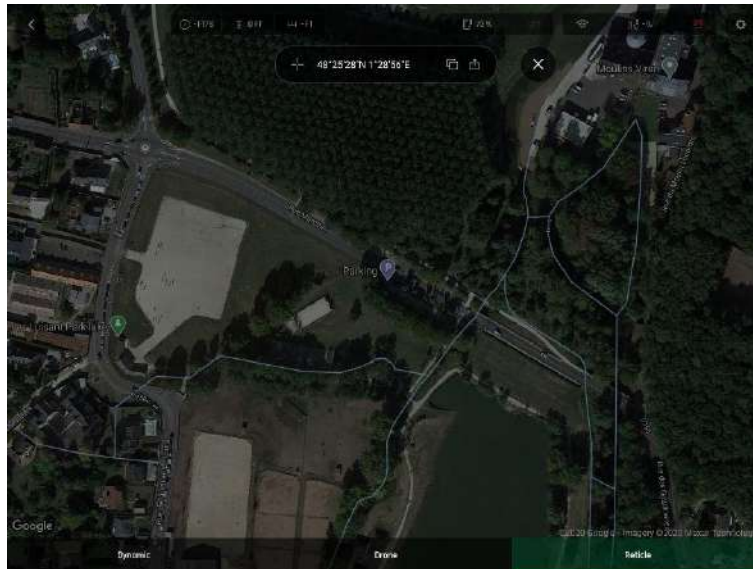

Coordinates options

Tap  **Copy** to copy coordinates to clipboard – and reuse as custom RTH point.

Tap an option at the bottom of the screen to select

Reticle (default) displays center of the map coordinates

Drone displays drone coordinates (when online), or last known position (when offline)

Dynamic displays drone, POI or WP coordinates (autonomous or assisted flights only*)

*Refer to the [“Map-based flying modes”](#) section of this guide for more information.

Tap  **Share** from coordinates options to open the Skycontroller USA sharing options.

Tap **X** to exit coordinate options and return to the full screen map.

Advanced RTH settings

The custom RTH option relies on managing coordinates, described in the previous section.

Activate advanced RTH settings through the Safety Preferences of FreeFlight 6 USA (refer to the [“PREFERENCES / Safety”](#) section of this guide for more information).

There are two advanced RTH options: Pilot & Custom.

CAUTION: By activating advanced RTH features, the drone might not be able to reach its destination in case of low battery, if you select return to **Pilot**, or a **Custom** position. Parrot will not be held responsible in the event that the drone lands in a different location.

Pilot RTH

When you select **Pilot** advanced RTH mode, ANAFI USA returns to the GPS position of the Skycontroller USA at the exact moment an RTH procedure is activated, or to the last known coordinates of the controller, in case it has lost GPS synchronization.

Parrot recommends that ANAFI USA pilots remain in the same location, after activating an RTH button, when in **Pilot** advanced RTH mode.

Custom RTH

When you activate the **Custom** advanced RTH option, set up ANAFI USA for a flight and it has a GPS synchronization, the current position of the drone appears in the “Custom point” field by default.

There are two ways to change this custom point.

- Paste the coordinates you copied from the map of FreeFlight 6 USA – refer to the earlier section of this guide.
- If you set up your drone for a flight, apply the following simple procedure to move the **Home** icon directly on the map of FreeFlight 6 USA.

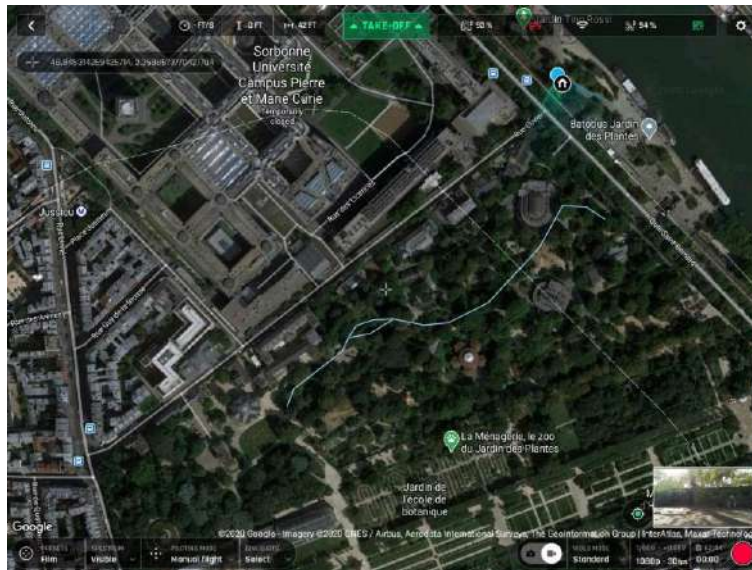

Initial home, at flight setup

The **Home** icon appears close to the drone icon, or exactly over the drone icon if the 1st GPS fix at power up was excellent, like in our example. The blue dot shows the position of the controller which is typically that of the pilot.

Tap the **Home** icon to activate it, then drag and drop it to your desired RTH point.



Home icon activated, ready to be dragged and dropped

In our example, we set up for a flight at a corner of a park, and planned an RTH over an open area, close to the center of the same park.

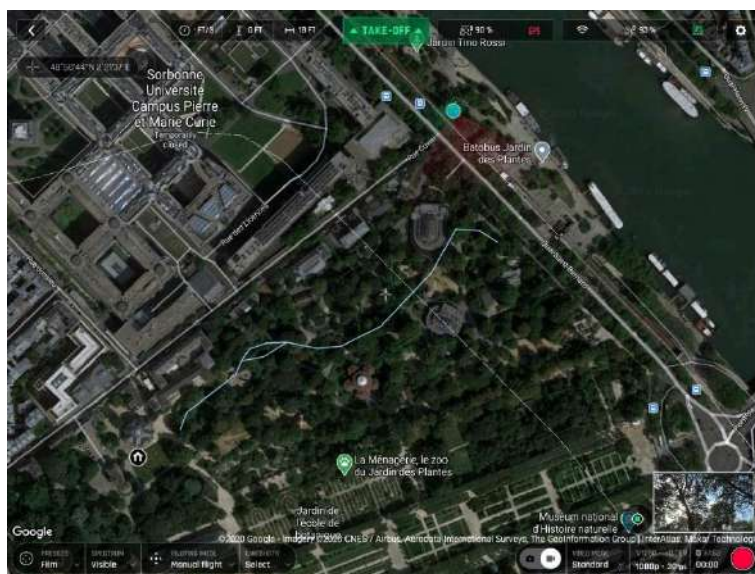

Custom RTH point set

Access **Safety Preferences** again and note the Custom point coordinates have been updated.

Landing

Fly ANAFI USA directly over a flat, even, and clear surface, then press **Take-off/Land**, or tap the orange **LAND** box on the screen.



The orange **LAND** box changes to **LANDING**. ANAFI USA lands.

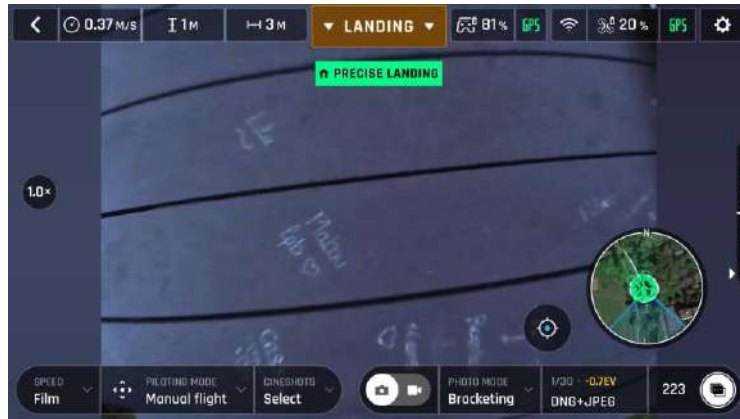

Precise Landing

Recovery from a moving vehicle

WARNING: Be especially careful when you recover ANAFI USA from a moving vehicle. It requires complete focus. Do not allow yourself to become distracted and stay aware of your surroundings. Always wear a strong glove to recover ANAFI USA.

Parrot recommends mobilizing two operators for this procedure: one operator pilots the drone, the second operator recovers ANAFI USA.

Before performing a drone recovery, reduce and stabilize the vehicle's speed as much as possible.

The pilot must present the rear of ANAFI USA on the side of the vehicle where the recovery operator is waiting for it.

The pilot must synchronize the lateral speed of the drone with that of the vehicle, and the altitude of the drone with that of the hand of the recovery operator.

When the drone is within the recovery operator's reach, his hand open, palm upward, he grabs the battery of the drone, from the bottom, under the drone's arms, between the thumb and the four other fingers.

Performing a quick wrist motion, the recovery operator turns the drone upside-down. ANAFI USA motors cut instantaneously.

Hand landing

A hand landing procedure is more dangerous than a ground landing. Be especially careful with the hand land feature. It requires complete focus. Do not become distracted and stay aware of your surroundings.

WARNING: DANGEROUS MANEUVER. RISK OF BODILY INJURY AND DAMAGE TO THE DRONE IN CASE

INSTRUCTIONS ARE NOT FOLLOWED. LACERATION HAZARD. Do not touch the propeller blades during flight. Propeller blades can cause deep cuts if your fingers, or other body parts, come into contact with them. Keep the drone as far away from your face as possible. Only attempt a hand landing on a stable surface, with no obstacles in the immediate vicinity.

WARNING: PARROT STRONGLY RECOMMENDS THAT YOU DO NOT PERFORM A HAND LANDING PROCEDURE INDOORS, DUE TO LOW STABILITY, AND INCREASED RISK.

Do not attempt a hand landing in wind strong enough to make the drone fight to hold its hovering position.

Drone GPS synchronization is mandatory for a successful hand landing.

Let the drone do the work. Do not forcefully grab the drone while it is hovering.

Parrot recommends that you work as a team of two people: one person to perform the hand landing procedure, while the other person focuses on flying the drone. This eases the pressure of having to multi-task.

Pay attention to the wind direction and speed. Do not face the wind. Keep yourself at a safe distance from the drone considering the possibility of drifting with the wind.

Fly ANAFI USA at least 50 cm directly over your open hand then press  **Take-off/Land** or tap the orange **LAND** box on the screen. ANAFI USA lands on your hand.

Only perform a hand landing procedure when there is no other landing alternative.

CAUTION: In environments with sand, you can use hand landing, instead of ground landing to prevent sand from penetrating the motors.

Smart LiPo Battery

One smart battery comes preinstalled on ANAFI USA. You can charge the smart battery when installed on ANAFI USA, or when removed from ANAFI USA. If you remove the battery, you must reinstall it in the same orientation. Ensure that you do not install the battery upside down as it can expose the battery and the drone to irreparable electrical damage. Always use genuine Parrot smart batteries. Non-genuine batteries are forbidden, and their use will void the warranty and impact safety requirements.

IMPORTANT: The LEDs and  **Power** button face up in the correct orientation.

NOTE: LiPo batteries gradually lose capacity after 300 charge/discharge cycles.

Battery removal

To remove the smart battery from the drone, unfold the drone's arms, press the push-button located on top of the battery and disengage it from the drone by gently sliding it toward the back of the drone.

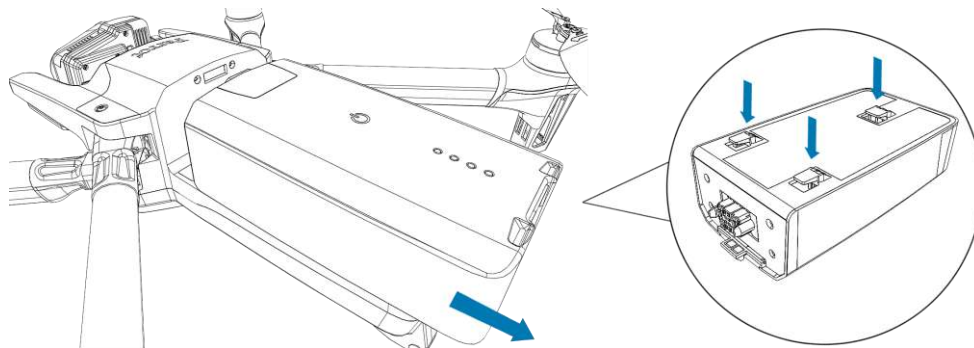

Battery installation

To install the smart battery on the drone, unfold the drone's arms. Position the battery's three hooks into the drone's corresponding slots and slide the battery firmly into the drone until you hear a click. Ensure that the battery is tightly secured into the drone.

Battery charging

To charge the smart LiPo battery, use the enclosed USB-A to USB-C cable to connect the battery to its enclosed charger. Alternatively, you can charge the battery from:

- a desktop or laptop computer's USB-A port.
- a power bank's USB-A port.

ANAFI USA's smart battery can also be recharged through a Power Delivery adapter or charger (USB-PD standard), using a USB-C to USB-C cable (not included in the box). In that configuration, full charging time of the battery can be reduced to 115 minutes.

IMPORTANT: Parrot does not recommend ANAFI USA users to invest in a USB-PD power bank, as not all of them support USB-C to USB-C charging of ANAFI USA's battery. Due to the nature of the USB-C technology, some USB-PD power banks recharge on ANAFI USA's smart battery, rather than the other way around.

CAUTION: Other generic USB chargers may be used provided that they are certified according to the country of use, and have the applicable rating/specification. Performance and warranty are only guaranteed when using the genuine charger included in the Parrot drone system.

When ANAFI USA’s smart LiPo battery is plugged into a power source and charging, its 4 LEDs indicate in real time the charge level:

LED 1	LED 2	LED 3	LED 4	Charge Level
				0 - 25% charged
				26 - 50% charged
				51 - 75% charged
				76 - 100% charged
				Fully charged

When the battery is not installed on ANAFI USA, you can check its charge level at any time by pressing the battery **Power** button:

LED 1	LED 2	LED 3	LED 4	Charge Level
				0 - 25% charged
				26 - 50% charged
				51 - 75% charged
				76 - 100% charged

When the smart LiPo battery is installed on the drone, and when ANAFI USA is powered on, the number of steady LEDs enables you to estimate your remaining flying time:

LED 1	LED 2	LED 3	LED 4	Remaining flight time
				less than 8 minutes
				9 -16 minutes
				17 - 24 minutes
				25 - 32 minutes

Battery care and safety

WARNING: Failure to follow all the instructions may result in serious injury, property damage and irreparable damage to the battery, ANAFI USA, Skycontroller USA, and may cause fire, smoke or explosion.

ANAFI USA’s smart battery features a wintering mode, designed to increase its durability and facilitate its care. Ideally, when not in use for a prolonged period, batteries should be stored half-charged. When not in use for 10 days, ANAFI USA’s smart battery discharges itself, if required, to 65% charge, over a 48h period.

After a maximum of 12 days without use, the smart battery enters hibernation with a charge level

which never exceeds 65%. During hibernation, the  **Power** button does not activate the charge level LED indicators. The battery must be charged to exit the wintering mode and start operating as described in the earlier paragraphs. This behavior preserves the battery over time.

TIP: always run a full charge of your smart battery before flying ANAFI USA.

ANAFI USA's smart battery must be handled, transported and stored with care:

- Do not store the battery long-term (1 month or more) with a charge level below 30%;
- never leave a battery unattended while charging;
- never expose a battery to extreme temperatures, neither hot, nor or cold;
- never charge a battery which is still warm from use (wait for at least 20 minutes);
- never use or recharge a damaged or swollen battery;
- always store your battery in a dry, ventilated place, at a temperature close to 20°C;
- always carry your battery in a fire-retardant bag or case (unless it is installed on ANAFI USA: it can then be transported with the drone, inside its carrying case).

IMPORTANT: the ideal long-term storage conditions for the battery are:

- at room temperature 23°C +/- 2°C;
- at a relative humidity of 65% (rh) +/- 20%;

NOTE: ANAFI USA's smart battery only charges in ambient temperatures between +10°C to +45°C. Flying time is reduced if you fly in temperatures approaching -10°C. The ideal operating temperature of the smart battery is 20°C. Ensuring that the smart battery remains as close as possible to 20°C before starting a flight minimizes the reduction in the smart battery's capacity in cold environments.

TIP: You can use your body heat to maintain the temperature of the battery. Keep the battery in your pocket prior to flying in a cold environment.

If the behavior of your battery is not consistent with the information in this section, and if the battery does not power your ANAFI USA, you must hard reset your battery. To perform a battery hard reset:

1. Plug the battery into a power source with the enclosed cable,
2. Press the  **Power** button for 15 seconds (regardless of the behavior of the LEDs).

The hard reset is successful if the battery's LEDs flash quickly, one after the other, alternating green and red.

Battery state of health

On the FreeFlight 6 USA homescreen:

1. tap the **Drone information** tile
2. tap the **Battery** tile.

The **Battery information** screen opens and provides the status of the following battery characteristics:

- | | | |
|----------------------------|--------------------------------|-------------------------------|
| - Serial number | - Charge level (%) | - Total Capacity (mAh) |
| - Software version | - Individual cell voltage (mV) | - State of health (%) |
| - Hardware revision | - Temperature (°C) | - Cycles |
| - First usage | - Total Voltage (V) | |

Battery update

ANAFI USA smart batteries can be updated, like the drone itself, its controller and its controlling software FreeFlight 6 USA. When a battery update is available with a FreeFlight 6 USA release, a message appears in the app. Follow the in-app instructions to update your battery.

CAUTION: Keep your battery plugged into a power supply throughout the software update procedure. Repeat the procedure with all your batteries.

MicroSD card and media management

This section explains how to install a microSD card in ANAFI USA and how to retrieve your media from the microSD card.

Installing a microSD card

The ANAFI USA microSD card slot is located under the battery. To install (or remove) a microSD card, you must remove the battery from the drone. Refer to the “[Battery removal](#)” section of this guide for more information.

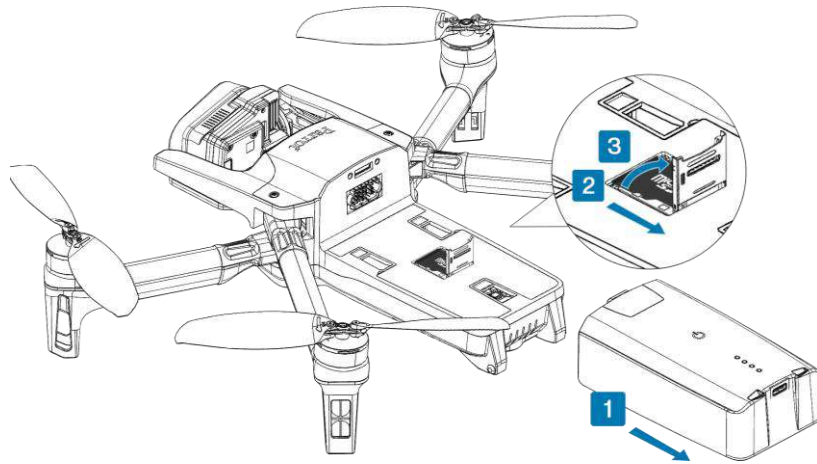

1. Remove the battery to expose the microSD card slot.

The microSD card slot is protected by a small metal lock.

2. To open the lock, slide it toward the back of the drone.

The lock makes a slight clicking sound.

3. The lock hinges at the back, lift the front part of the lock to open the slot.
4. Insert the microSD card into the keyed slot.

IMPORTANT: In the correct orientation, the microSD card’s metal contacts face down. The shortest side of the microSD card faces toward the back of the drone. A **closed-lock-with-arrow** icon , located to the right of the microSD slot, confirms how you must slide the lock secure it in place.

5. To close the lock, push it back down toward the drone body.
6. Slide the lock toward the front of the drone body to fully close and lock it.

The lock makes a slight clicking sound.

Retrieving photos and videos

1. Remove the microSD card from the drone.
2. Insert the microSD card into the microSD card slot on your computer.

If your computer does not have a microSD card slot, you must use a microSD to SD card adapter.

3. Copy the videos and photos taken with ANAFI USA to the computer hard drive to store, edit, and manage the media.

TIP: Parrot recommends you backup your photos and videos, and you empty your microSD card after each flight, to ensure you always have available memory space to capture new still or moving images.

Compatible microSD cards

Refer to Parrot's [online documentation](#) for an updated list of compatible microSD cards.

Direct media retrieval (drone to computer)

Alternatively, retrieve the media directly from ANAFI USA, without extracting the microSD card.



Use an enclosed USB-A to USB-C cable to connect the drone (USB-C) to a USB-A port on your computer. Press **Power** to power on ANAFI USA.

ANAFI USA mounts as an external drive. Copy your media from the **DCIM/100MEDIA** directory to your computer's hard drive.

When you finish managing your media, click **Safely Remove Hardware** in the Windows taskbar, then click **Eject ANAFI USA**, like any other external drive.

NOTE: When plugged in to a computer and powered on, ANAFI USA's battery discharges itself. You must recharge your smart battery after you retrieve your media, even if the battery was fully charged when you began the procedure.

FreeFlight 6 USA Gallery

You can access the **Gallery** from the FreeFlight 6 USA homescreen. Tap either the  **microSD card** icon on the top bar of the interface, or the  **Gallery** tile, at the center of the interface.

The **Gallery** has 2 tabs at the top of the interface; **SD CARD**, and **LOCAL**.

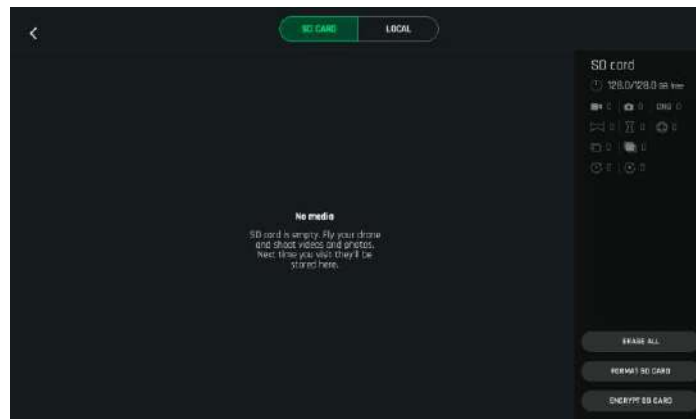

NOTE: If ANAFI USA is powered on and connected to the device (directly or through the Skycontroller), the FreeFlight 6 USA **Gallery** displays the microSD card media, by default.

Tap any media to preview it.

Tap any green media download box to transfer the corresponding media to your device.

Tap the **LOCAL** tab to access any media you download to your device.

The **Gallery** also lets you:

- preview videos and photos, without downloading them to your device;
- create panoramas (refer to the "[Creating panoramas](#)" section for more information);
- erase all media
- format a microSD card;
- encrypt a microSD card.

MicroSD card formatting

To format the microSD card:

1. Tap the **SD CARD** tab
2. Tap **FORMAT SD CARD**
3. **Select the type of formatting** from one of the following options:

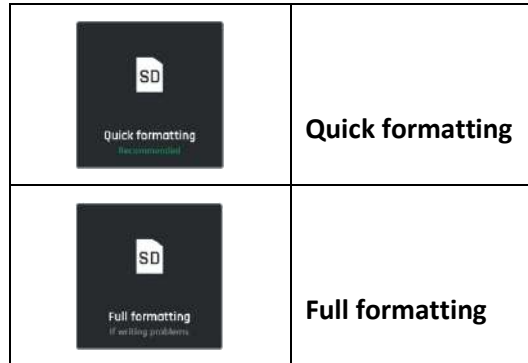

Confirm your selection from the next screen to launch the formatting.

CAUTION: Both options erase all data stored on the microSD card's memory, including flight data.

MicroSD card encryption

CAUTION: If you encrypt a microSD card, you also initiate the formatting process that erases all data stored on the card's memory.

To encrypt the microSD card:

1. Tap the **SD CARD** tab
2. Tap the gray **ENCRYPT SD CARD** button

The **Encryption profiles** screen opens.

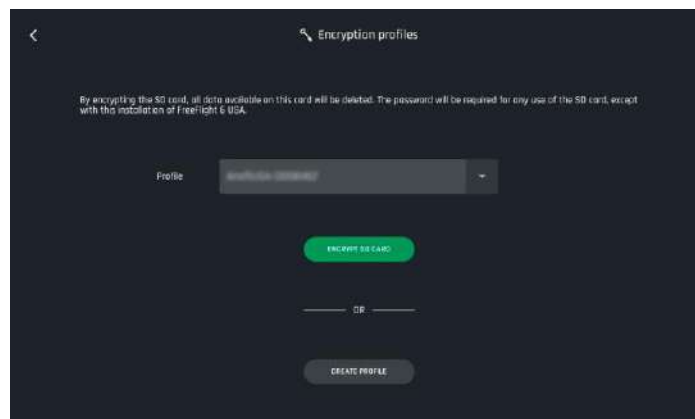

3. Tap **CREATE PROFILE** to create a new encryption profile. Alternatively, select an existing **Profile** from the drop-down menu.

If you create a new profile, the **Create profile** screen opens.

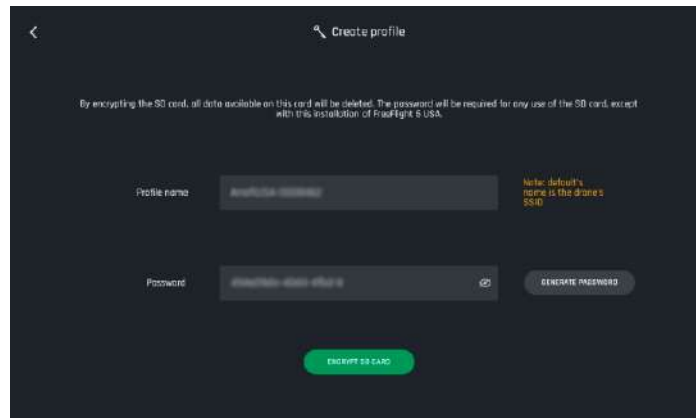

4. Type your own **Password** or tap **GENERATE PASSWORD**.
5. Tap the green **ENCRYPT SD CARD** button to launch the encryption.

The **Encryption profiles** screen opens again. A green loading circle shows that the encryption process is underway.

The encryption is successful when the **ENCRYPT SD CARD** button (in Step 3) in the **SD CARD** tab, changes to  **LOCKED**.

A microSD card encrypted by ANAFI USA is unreadable without the associated Encryption profile.

The Encryption profile is held by the instance of FreeFlight 6 USA, thus by the device with which the encryption was performed.

Consequently, if a drone is destroyed, its microSD card can only be decrypted through:

- the Skycontroller USA which holds the microSD card's Encryption profile;
- another ANAFI USA drone paired to that Skycontroller USA.

To remove the encryption from the microSD card:

1. Navigate to the FreeFlight 6 USA **Gallery**
2. Tap the **SD CARD** tab
3. Tap the **LOCKED** button

The **Encryption profiles** screen opens, and shows the **Profile list**.

4. Select the profile from which you want to remove the encryption.
5. Tap **REMOVE ENCRYPTION**

The **Remove encryption** screen opens.

6. Tap **REMOVE AND FORMAT**

The decryption is successful when the  **Locked** button (in Step 3) in the **SD CARD** tab, changes to **ENCRYPT SD CARD**.

RTSP video stream sharing

This section details the VLC stream sharing procedure. You can set up the sharing procedure at any stage of a flight.

You can share the video stream of ANAFI USA, via RTSP protocol, to a PC equipped with VLC media player.

You can also share the stream by using the open command line tool FFmpeg.

NOTE: To enable this feature, you must ensure that:

- FreeFlight 6 USA is set to the main piloting HUD.
- The drone stream is available.

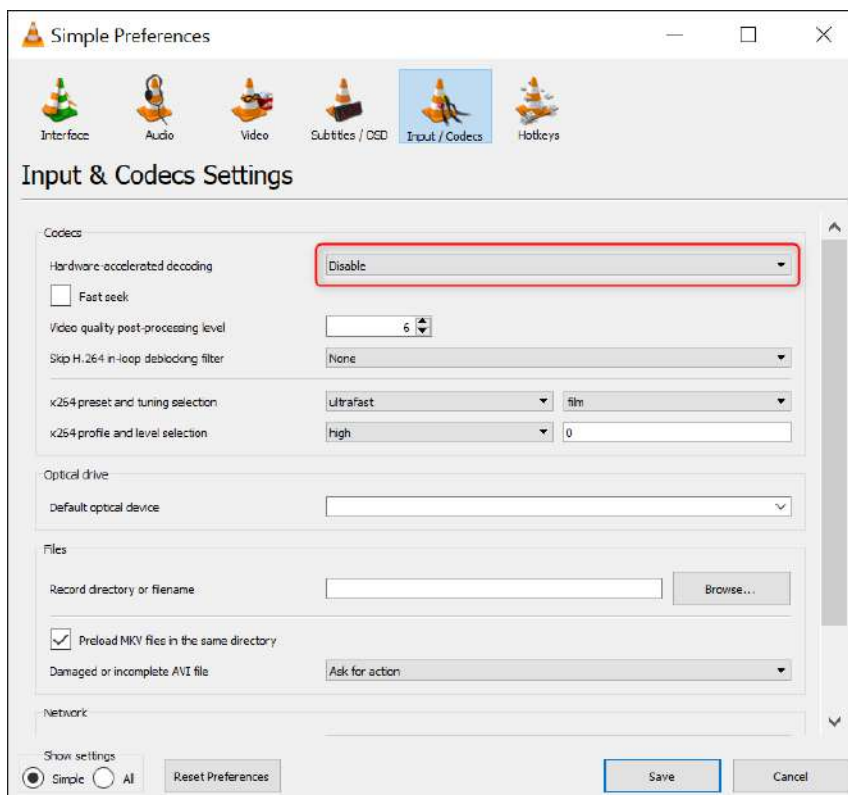

1. Power on Skycontroller USA and connect it to a PC (host) via an RJ45 cable.
2. Connect ANAFI USA to Skycontroller USA via Wi-Fi.
3. Launch VLC media player on the host PC.
4. In the top menu bar, click **Tools**. A dropdown menu opens. Click **Preferences**. The **Simple Preferences** interface opens.
5. Click the **Input / Codecs** tab.
6. Click the dropdown menu for **Hardware-accelerated decoding**. Click **Disable**.

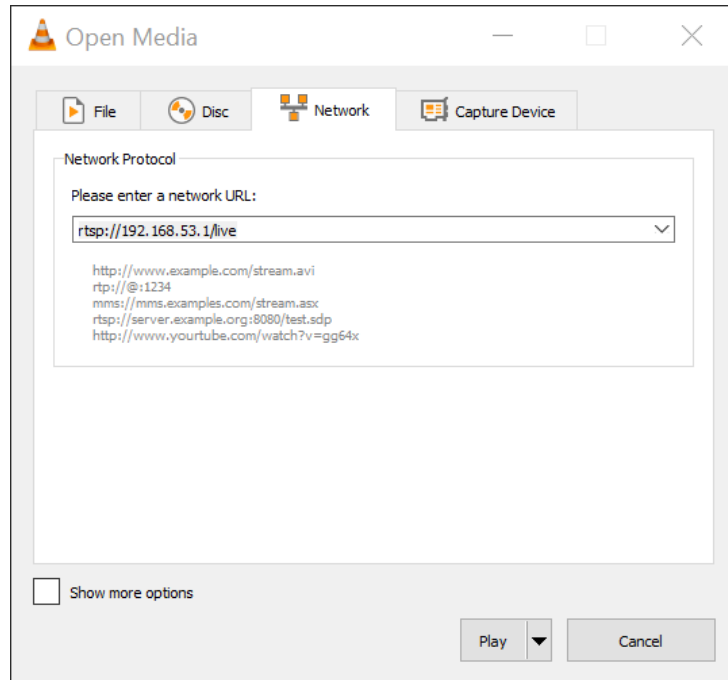

7. Click **Save** to save your selection, and to close the **Simple Preferences** interface.

8. In the top menu bar, click **Media**. A dropdown menu opens. Click  **Open Network stream**. The **Open Media** interface opens.
9. There is an input field under **Please enter a network URL:** Enter `rtsp://192.168.53.1/live`, as shown in the following image.



10. In the playback controls on the bottom left of the screen, click  **Loop** one time to enable the **loop all** mode.
11. Click  **Play** to launch the stream in the main window of VLC.



Introducing FreeFlight 6 USA

The HUD (heads-up display) interface of FreeFlight 6 USA enables you to access all the features of ANAFI USA, from the screen of your Skycontroller USA.

This section explores FreeFlight 6 USA functions, starting with a presentation of the top and bottom bars of the HUD.

Access the HUD by tapping **FLY** on the bottom right of the homescreen of FreeFlight 6 USA.

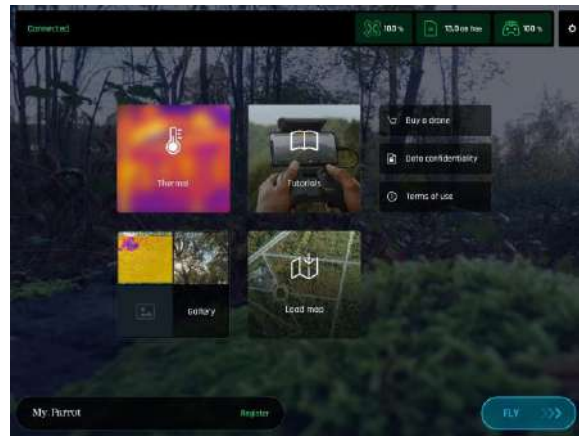





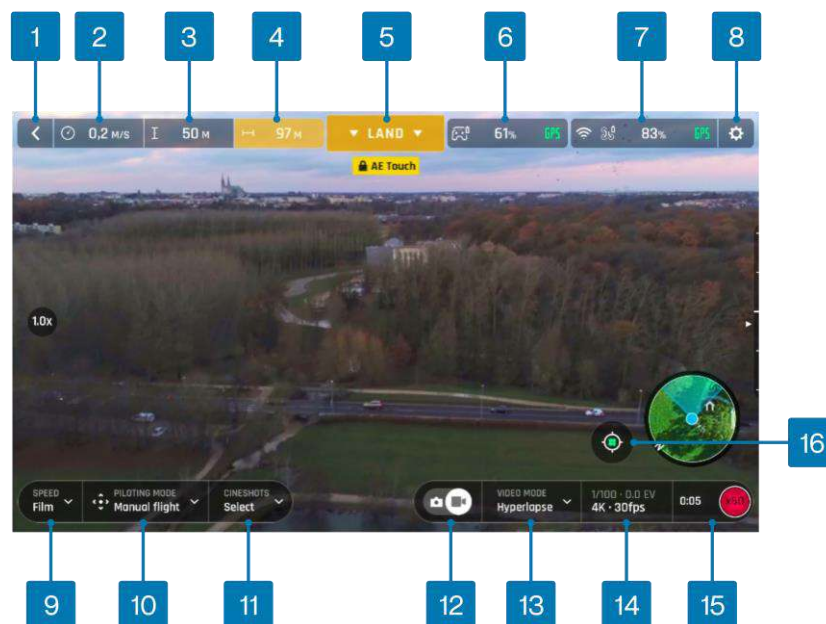











FreeFlight 6 USA homescreen

Presentation of the HUD



- | | |
|--|---|
| <ol style="list-style-type: none"> 1. < Back to homescreen 2. ⌚ Drone ground speed 3. ≡ Drone altitude relative to take-off point 4. ⇄ Drone horizontal distance from pilot 5. Next available action 6. 🔋 Controller battery & device GPS statuses 7. 🔋 Drone battery & GPS statuses 8. ⚙️ PREFERENCES | <ol style="list-style-type: none"> 9. Speed box 10. PILOTING MODE box 11. CINESHOTS box 12. 📷 Photo/video toggle 13. PHOTO/VIDEO MODE box 14. Image settings box 15. ⏸️ Soft shutter & timer/No. of media 16. 🗺️ Map center toggle (Pilot/Drone) |
|--|---|

Overview of current drone Piloting, Cineshots, Dronies, Photo and Video modes:

Piloting modes:	<ul style="list-style-type: none">  Manual flight  Cameraman  Follow Me  Smartdronies  FPV  Flight Plan  Touch & Fly 	Cineshots:	<ul style="list-style-type: none">  360° (left & right)  Reveal (30 & 60m)  Spiral (30 & 60m)  Epic (30 & 60m)
Video modes:	<ul style="list-style-type: none">  Standard  Cinema  Hyperlapse  High-Framerate  Slow Motion 	Smartdronies & POI Dronies:	<ul style="list-style-type: none"> Orbit Parabola Dolly Zoom Boomerang
Photo modes:	<ul style="list-style-type: none">  Single  Timer  Burst  Bracketing  Panorama  Timelapse  GPS Lapse 	Follow Me Dronies:	<ul style="list-style-type: none"> Orbit Parabola Tornado Boomerang

NOTE: Some modes are not available in the Light interface. Refer to the "[PREFERENCES / Interface / Light interface](#)" section of this guide for more information.

TIP: Ensure that both GPS icons are green (and not red) before you make ANAFI USA take off. This means that the Skycontroller USA and ANAFI USA are both synchronized to enough GPS, GLONASS, and Galileo satellites to optimize the stability of the drone, especially at higher altitudes.

Preferences

Tap  Settings on the top right of the homescreen, or the HUD, to access **PREFERENCES**. Preferences enable you to fine-tune ANAFI USA to customize it to your piloting and filming styles. Access Preferences submenus from the tiles on the left of the screen.

For all items, default values (DV) are marked in bold characters.



Skycontroller USA can change between a **FULL** interface and a **LIGHT** interface. Asterisks (*) signal menu items which disappear in Light interface. Tap **Interface**, then tap **FULL** or **LIGHT** to toggle between interfaces. Refer to the "[PREFERENCES / Interface / Light interface](#)" section of this guide for additional information.

Controls

The  **Controls** preferences set the way your controller behaves. It also enables you to activate the **Hand-launch** option.

Tap an item option to select it. When you select an option, the icon turns from white to green.

Controls PREFERENCES







Control mode*	CLASSIC / ARCADE (only available in flight)
Options:	
 Inverse joys	OFF / ON
 Special	OFF / ON
 EV Trigger*	OFF / ON
Hand-launch	NO / YES

NOTE: The EV Trigger function is not useful for Skycontroller USA users, as this remote control has two direct access buttons to control image exposition.

Tap **RESET ALL CONTROL PREFERENCES** to reset  **Controls** preferences to the default values.

Presets

The  **Presets** preferences allow you to adapt the flight behavior of ANAFI USA for:

- The four modes in the Full interface  **FILM**,  **SPORT**,  **CINEMATIC** and  **RACING**.
- The two modes in the **Light** interface:  **Slow** &  **Fast**.

Presets PREFERENCES

Global reactivity	1% to 100% (DV: 100% for FILM , and SPORT ; 15% for CINEMATIC ; 30% for RACING)
Gimbal:	
Horizon	FIXED / DYNAMIC (DV: FIXED for FILM , and SPORT ; DYNAMIC for CINEMATIC , and RACING)
Camera tilt speed	1°/s to 180°/s (DV: 20°/s for FILM , SPORT , and RACING ; 10°/s for CINEMATIC)

⚙️ Flight:	
Banked turn	NO / YES (DV: YES for FILM , CINEMATIC & RACING ; NO for SPORT)
Inclination	1°/s to 40°/s (DV: 7°/s for FILM ; 20°/s for SPORT , and CINEMATIC ; 25°/s for RACING)
Vertical speed	0.1m/s to 4m/s (DV: 1.4m/s for FILM ; 4m/s for SPORT ; 2.4m/s for CINEMATIC ; 3m/s for RACING)
Rotation speed	3°/s to 200°/s (DV: 40°/s for FILM , and RACING ; 80°/s for SPORT ; 20°/s for CINEMATIC)

NOTE: Tap **Info** for more information about **Horizon** and **Banked turn**.

CAUTION: **Global reactivity**, **Inclination**, **Vertical speed** and **Rotation speed** values have the biggest impact on ANAFI USA's acceleration and general flying behavior. Corresponding sliders turn to orange instead of green to warn users the settings they have selected require extreme care, superior piloting skills, or both, when flying ANAFI USA. Your drone will always remain very responsive, but with extreme settings, it will accelerate much more rapidly.

Tap **RESET ALL PRESETS PREFERENCES** to reset  **Presets** preferences to the default values.

Thermal

The  **Thermal** preferences deal with specific thermography settings.

Thermal PREFERENCES

Color gradient	Fusion / Rainbow / White Hot / Black Hot
Thermal post-processing	NO / YES
Thermal sensor calibration	AUTO / MANUAL
Temperature range	DEFAULT / VERY HIGH TEMPERATURES

Thermal post-processing

Tap **Info** for more information about **Thermal post-processing**. Parrot recommends **NO** for real time operations, and **YES** for post flight analysis operations.

Thermal calibration

AUTO mode is recommended for most users. If you select the **MANUAL** mode, the application will periodically remind you to calibrate your thermal camera, through the dedicated  button of your HUD.

Tap **RESET ALL THERMAL SETTINGS** to reset  **Thermal** preferences to the default values. This button also reinitializes thermal Spot and Absolute scales to default values, as well as visible and thermal images blending.

Special

 **Special** preferences manage the disabling of the LEDs of the drone and of the RTH function.

Special PREFERENCES

Disable drone LEDs	NO / YES
Return to Home (RTH)	NO / YES

RTH function

If you disable this function, you also disable all RTH-linked alerts. This is useful to explore cluttered, closed, or confined environments, as it disables any activation of the RTH procedure (raise to a minimum of 20m, return to the take-off position – by default). However, it requires the pilot to pay particular attention to the drone's battery level. It also prevents any automatic drone return in case of Wi-Fi communication breakdown.

Tap **RESET ALL SPECIAL SETTINGS** to reset **Special** preferences to the default values.

Interface

 **Interface** preferences define the information which appears on your FreeFlight 6 USA HUD.

Interface PREFERENCES

Interface	FULL / LIGHT
Show minimap*	NEVER / WITH CONTROLLER / ALWAYS
Display GPS position*	YES / NO
Coordinates system*^[1]	LATLNG / MGRS / UTM / DMS
Time zone	SYSTEM TIME / UTC
Map type	ROADMAP / SATELLITE / HYBRID
Map Engine	GOOGLE MAP / MAPLIBRE
Show framing grid*	NO / 3 x 3 / 6 x 6
Measurement system	AUTO / IMPERIAL / METRIC
FPV Goggles – tap CHANGE to select from these options:	Parrot – CockpitGlasses 1 Parrot – CockpitGlasses 2 Parrot – CockpitGlasses 3 Google – DayDream View Homido V2 Homido Prime Homido Merge VR BNext Skillkorp VR5 Zeiss VR One

Tap **TEST** to verify the rendering of your **FPV Goggles** selection.

Light interface

The **Light** interface limits the number of items in the **PREFERENCES** menus and the number of options (photo, video, piloting modes, styles) available in the HUD.

The menu items which disappear in the **Light** interface are signaled in this section by asterisks (*).

HUD Options remaining in Light interface:

Photo	Single, Panorama, Timelapse, GPS Lapse
Video	Standard 1080p only (24, 25 or 30 fps)
Piloting modes	Manual flight, Cameraman, Flight Plan, Touch & Fly
Style (image)	Natural only (with adjustment)

[1] Coordinates systems

LATLNG	latitude and longitude
MGRS	Military Grid Reference System (NATO's geocoordinate standard)
UTM	Universal Transverse Mercator
DMS (or D°M'S")	degree, minute, second (of arc)

3 x 3 framing grid

The **3 x 3** framing grid facilitates building entries, through a door or a window.

Tap **RESET ALL INTERFACE PREFERENCES** to reset  **Interface** preferences to the default values.

Safety

 **Safety** preferences allow you to create a safe and clear flying area for ANAFI USA.

When the **Geocage** is activated, ANAFI USA will automatically stop when it reaches the maximum height or the maximum distance you select. A red prompt will also appear on your HUD.

 Safety PREFERENCES

Geocage	NO / YES
Max height	1m to 150m (DV: 30m)
Max distance	10m to 4 km (DV: 300m)
Minimum height when using RTH	20m to 100m (DV: 30m)
End behavior	HOVERING / LANDING
Hovering height	1m to 10 m (DV: 2m)
Advanced RTH settings	NO / YES
Return position	TAKE-OFF / PILOT / CUSTOM

NOTE: By activating advanced RTH features, if you select return to **Pilot** or **Custom** position, the drone might not be able to reach its destination in case of low battery. Parrot will not be held responsible in the event that the drone lands in a different location.

End behavior and Hovering altitude

Parrot recommends ending RTH sequences by hovering (default value) as it enables the pilot to control the end of the flight. However, for missions at sea, Parrot recommends you modify the hovering altitude over 2m (default value). Up to 2m, at the end of the RTH, the drone will compute its height over the ground, with its ultrasonic sensor. Above 2m, it will compute its height over its take-off point, with its barometer.

For example, if the drone takes off from the deck of a ship, 40m above sea level, with a hovering altitude set at 2m, at the end of the RTH, the drone will look for the ground and could stop 2m above the surface of the sea.

If it takes off with a hovering altitude set at 3m, it will stop 43m (40 + 3) above the surface of the sea.

Tap **RESET ALL SAFETY PREFERENCES** to reset  **Safety** preferences to the default values.

Camera

■ **Camera** preferences allow you to select camera options, both in photo and video modes.

■ Camera PREFERENCES

Camera calibration	– Tap	Correct horizon, Gimbal calibration and Cameras alignment
CALIBRATE		
Auto record from take-off		NO / YES (video only)
Lossless zoom only		NO / YES
Display overexposure		NO / YES
Anti-flickering		AUTO / 50Hz / 60Hz / OFF

Correct horizon and cameras alignment

Only resort to the **Correct horizon** and the **Cameras alignment** procedures if you notice your videos and photos are systematically tilted on the same side or if your visible and thermal cameras are misaligned. Refer to the “[Camera Calibration](#)” section of this guide for the detailed procedures.

Display overexposure

When this setting is activated, the HUD of FreeFlight 6 USA shows all overexposed areas of the screen as hatched, which enables you to fine-tune your framing, your EV settings, or both.

Anti-flickering

This setting and the associated technology aim to eliminate the flicker effect which can arise due to some artificial lights. The **AUTO** option should work for most users, but depending on your country, you can try other settings if you feel bothered by a flicker effect on the screen, your artificial light videos, or both.

Tap **RESET ALL CAMERA PREFERENCES AND SETTINGS** to reset ■ **Camera** preferences to the default values.

Network

📶 **Network** preferences let you change your ANAFI USA’s connectivity options, Wi-Fi network name, password, and band.

📶 Network PREFERENCES

Broadcast DRI	OFF / ON
Network name	Tap the field to change your ANAFI USA’s network name. Tap PASSWORD to enter the password.
Wi-Fi band	AUTO / MANUAL

Tap **PASSWORD** to define the Wi-Fi key shared by ANAFI USA and the Skycontroller USA. Parrot defines a unique random password for each ANAFI USA and Skycontroller USA package, but Parrot highly recommends you define your own password.

The security of your ecosystem and data depends on the security of this password. Your password be at least 10 characters long, and must use at least 3 types of characters among:

- Uppercase characters,
- Lowercase characters,
- digits,
- special characters.

Direct Remote Identification (DRI)

The DRI system makes your drone locally broadcast information about itself for regulatory compliance (where applicable).

Manual Wi-Fi band setting

Tap the **MANUAL** tile in **Wi-Fi band**, then touch a free band to select it.

In urban environments, 5 GHz Wi-Fi channels typically suffer less interference than 2.4 GHz channels. The following table shows the recommended Wi-Fi channels depending on your geographical zone, and environment.

Geographical Zone	Recommended Wi-Fi channels in urban environment	Recommended Wi-Fi channels in non-urban environment
Australia	149 - 165	1 – 11
Canada	149 - 165	1 – 11
Europe	149 - 165	1 – 11
Japan	1 - 11	1 – 11
Singapore	1 – 11	1 – 11
South Africa	1 – 11	1 – 11
South Korea	149 - 165	1 – 11
Taiwan	149 - 165	1 – 11
United Kingdom	149 - 165	1 – 11
Ukraine	149 - 165	1 – 11
United Arab Emirates	149 - 165	1 – 11
United States	149 - 165, (36 - 48 less power)	1 - 11, 149 – 165

To enable the automatic optimization of Wi-Fi communications on the 5 GHz channels, manually select a 5 GHz channel, then revert the Wi-Fi band setting to **AUTO**.

External antennas

The Skycontroller USA is equipped with two external 50 ohm coaxial female antenna connectors (TNC), which enable you to connect it to external antennas.

Compatible passive antennas must respect the following specifications:

Connectors	male TNC
Frequencies	2400-2480 MHz, 5150-5250 MHz, and 5750-5850 MHz
Gain	>5 dBi
Polarization	Vertical
Radiation pattern	Omnidirectional
Impedance	50 ohms
Cable length	as short as possible to limit losses

Installing external antennas

1. Remove the protective caps from the female TNC connectors of the Skycontroller USA.
2. Screw the external antennas male TNC connectors to the female TNC connectors of the Skycontroller USA.

Activating external antennas

1. Power the Skycontroller USA on.
2. Wait until FreeFlight 6 USA launches.
3. Press and hold simultaneously the **+ Plus**, **- Minus**, and  **Optics reset** buttons of the Skycontroller USA.
4. The status LED of the Skycontroller USA turns to turquoise.
5. The external antennas are activated, and the inbuilt antenna of the Skycontroller USA is deactivated.

Reverting to the inbuilt antenna

1. Power the Skycontroller USA on.
2. Wait until FreeFlight 6 USA launches.
3. Press and hold simultaneously the **+ Plus**, **- Minus**, and  **Optics reset** buttons of the Skycontroller USA.
4. The status LED of the Skycontroller USA turns to dark blue.
5. The external antennas are deactivated, and the inbuilt antenna of the Skycontroller USA is activated.

Videos, Photos, and Panoramas

ANAFI USA is equipped with a 3-axis-stabilized gimbal, which is capable of motion and still pictures, through two 1/2.4" CMOS 21MP sensors. The lenses of the cameras include low dispersion aspherical elements, that reduce chromatic aberrations and flare. FreeFlight 6 USA has multiple configurable settings, from full auto to manual professional options.

Making videos

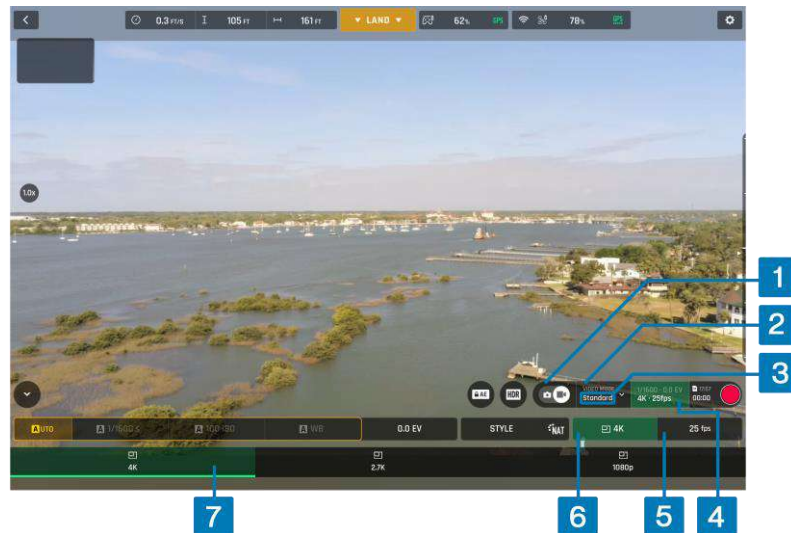

Video options - MODE options not shown, 4k with 25 fps

To access ANAFI USA's video options:

1. Tap the **photo/video** toggle in the HUD, to circle the film camera (right icon) in white.
2. Tap the **VIDEO MODE** box (mode menu not shown on the screenshot)
3. Tap a video mode to select it (**Standard** mode is selected on the screenshot)
4. Tap the **Image settings** box to open the video settings menu.
5. Tap the **Framerate** box to select the fps value (25 fps in screenshot)
6. Tap the **Resolution** box
7. Select **4k**, **2.7k**, or **1080p** from the **Resolution menu** (4k resolution in screenshot).
8. Tap the **Image settings** box again to close the sub-boxes and confirm your choices.

Available video resolutions and fps values depend on the video mode you select:

<input type="checkbox"/> Standard	all-round 4K, 2.7K or 1080p filming, at 24, 25 or 30fps.
<input type="checkbox"/> Cinema	spectacular 4K cinema filming, at 24fps .
<input type="checkbox"/> Hyperlapse	time-lapse video with a configurable speed factor (x15, x30, x60, x120, x240), in 4K, 2.7K or 1080p , exported at 24, 25 or 30fps .
<input type="checkbox"/> Slow-Motion:	filming at 48, 50 or 60fps , automatically slowed down by a factor of 2
1080p	(x0.5) and exported at 24, 25 or 30fps.
720p	filming at 96, 100 or 120fps , automatically slowed down by a factor of 4
	(x0.25) and exported at 24, 25 or 30fps.
<input type="checkbox"/> High-Framerate	1080p filming at 48, 50 or 60fps (ideal for post-processing) and 720p filming at 96, 100 or 120fps .

Press Skycontroller USA's **Media recording** button (or tap the HUD's **soft shutter** button) to start filming.

The HUD **soft shutter** button animates and displays a cycle between a red square and red circle. The

timer starts running.

Press the **Media recording** button (or tap the **soft shutter** button) again to end the recording. The HUD's **soft shutter** button returns to steady red, and round. The timer resets.

Taking photos

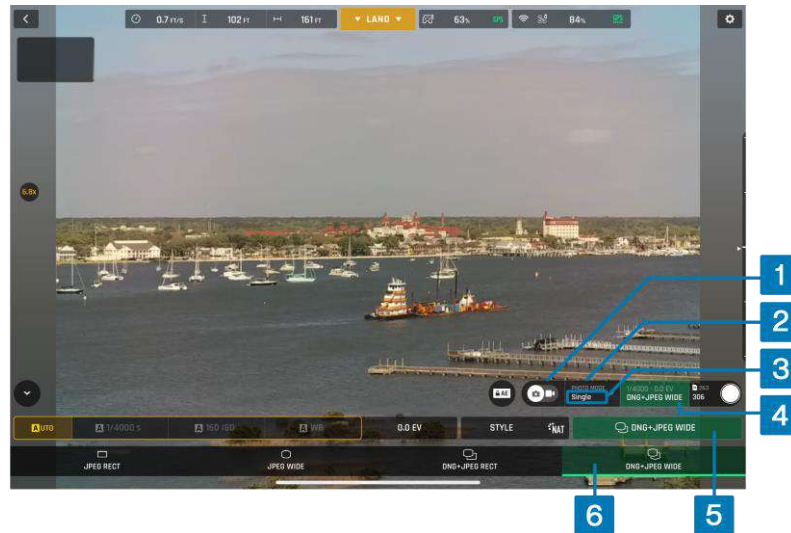

Photo options - MODE options not shown, DNG+JPEG WIDE

To access ANAFI USA's photo options:

1. Tap the **photo/video** toggle in the HUD, to circle the photo camera (left icon) in white.
2. Tap the **PHOTO MODE** box.
3. Tap a photo mode from the corresponding menu in the HUD (mode menu is not shown on the screenshot, **Single** mode is selected).

7 photo modes are available on ANAFI USA:

Available photo formats for each photo mode:

<input type="checkbox"/> Single	JPEG RECT, JPEG WIDE, DNG+JPEG (RECT or WIDE)
Timer	JPEG RECT, JPEG WIDE, DNG+JPEG (RECT or WIDE)
Burst	JPEG RECT, JPEG WIDE
Bracketing	JPEG RECT, JPEG WIDE, DNG+JPEG (RECT or WIDE)
Panorama	JPEG RECT only
Timelapse	JPEG RECT, JPEG WIDE, DNG+JPEG (RECT or WIDE)
GPS Lapse	JPEG RECT, JPEG WIDE, DNG+JPEG (RECT or WIDE)

4. Tap the **Image settings** box to open the photo settings menu.
5. Tap the **Photo formats** box.

ANAFI USA Photo formats

<input type="checkbox"/> JPEG RECT	4:3 aspect ratio, up to 16MP and 75.5° HFOV - <i>Horizontal Field Of View</i>
<input type="checkbox"/> JPEG WIDE	4:3 aspect ratio, 21MP, up to 84° HFOV – zoom is disabled for this format
DNG+JPEG RECT	4:3 aspect ratio, 21MP, up to 84° HFOV – zoom is disabled for this format
DNG+JPEG WIDE	4:3 aspect ratio, 21MP, up to 84° HFOV – zoom is disabled for this format

6. Tap a format (**JPEG RECT**, or **JPEG WIDE** if available, or any **DNG+JPEG** if available) to select it.
7. Tap the **Image settings** box again to close the sub-boxes and confirm your choice.

NOTE: The **DNG+JPEG** option produces at least 2 files: 1 DNG (*Digital NeGative*), 1 JPEG, for each shutter action. DNG is a RAW format. RAW formats retain all the information gathered by photography sensors, contrary to JPEG formats, which are compressed and processed renderings of this comprehensive information. As a result, RAW pictures such as DNG images are heavy files, but they provide the best post-processing and retouching possibilities.

When you select a photo mode, the HUD **Soft shutter** button appears as a full grey (ANAFI USA landed) or white (ANAFI USA flying) circle.

 **Single** mode has no options. It takes 1 photo each time you press the shutter. The HUD **soft shutter** button appears as a full white circle. The screen flashes black and white to confirm a picture has been taken. The number to the left of the HUD **Soft shutter** button (the number of media on the microSD card) increases by 1.

 **Timer** mode has 3 options: **3s**, **5s**, and **10s**. When you select an option, the HUD **Soft shutter** button displays either **3s**, **5s**, or **10s** depending on the option. The countdown is displayed at the center of the HUD, and on the **Soft shutter** button. The screen flashes black and white to confirm a picture has been taken. The **Soft shutter** button timer resets. The microSD card saved media number increases by 1.

 **Burst** mode has no options. The HUD **Soft shutter** button displays the burst icon inside a white circle. The screen flashes black and white to confirm 14 pictures have been taken in the span of 1 second. The microSD card saved media number increases by 14.

 **Bracketing** mode has 3 options: **3 photos** (-1 EV, +0.0 EV, +1 EV), **5 photos** (-2 EV to +2 EV) and **7 photos** (-3 EV to +3 EV). When you select an option, the HUD **Soft shutter** button displays the bracketing icon inside a white circle. The screen flashes black and white to confirm 3, 5 or 7 pictures have been taken. The microSD card saved media number increases by 3, 5 or 7, depending on the option.

 **Panorama** mode has 3 options: **Vertical**, **Horizontal**, and **360**. When you select an option, the HUD **Soft shutter** button displays the corresponding icon inside.

 **Timelapse** mode has 6 options: **5s**, **10s**, **15s**, **30s**, **60s**, and **120s**. When you select an option, the HUD **Soft shutter** button displays the timelapse icon. The screen flashes black and white to confirm a picture has been taken. The drone continues to take photos every 5 to 120 seconds, depending on the option, until you press the shutter button again to stop the timelapse. Between each shutter action, a green progress bar, at the bottom of the screen, serves as a countdown. At the end of the timelapse, the microSD card saved media number reflects the total number of medias on the drone's microSD card.

 **GPS Lapse** has 6 options: **5 m**, **10 m**, **20 m**, **50 m**, **100 m**, and **200 m**. When you select an option, the HUD **Soft shutter** button displays the GPS Lapse icon. The screen flashes black and white to confirm a picture has been taken. The drone continues to take photos when it reaches any point on a 5 to 200-meter radius around the initial photo, depending on the option, until you press the shutter button again to stop the GPS Lapse. Between each shutter action, a green progress bar, at the bottom of the HUD, lets you estimate the distance the drone must cover before the next shot. At the end of the GPS Lapse, the microSD card saved media number reflects the total number of medias on the drone's microSD card.

Creating Panoramas

ANAFI USA panoramas are generated automatically through the FreeFlight 6 USA gallery, based on a series of pictures taken by the drone.

NOTE: ANAFI USA cannot proceed with a panorama if the drone battery power is low (capturing a 360 Panorama takes ANAFI USA up to 90 seconds).

The generation of a panorama, regardless of its format, has 3 phases:

- collecting the pictures in flight;
- downloading the pictures from ANAFI USA to Skycontroller USA;
- stitching the pictures together to create the panorama in the FreeFlight 6 USA gallery.



Before shooting a panorama:

1. Ensure that you are not flying lower than 10 meters (30ft) over water.
2. Ensure that no object or subject is present within a 10-meter (30ft) radius around ANAFI USA. This optimizes the stitching process.

NOTE: ANAFI USA locks the exposure locking of the frame with which you start your panorama with. For this reason, Parrot recommends you always frame the main subject of the intended panorama before pressing the shutter button. Refer to the "[Lock AE](#)" section for more information.



To capture a panorama, tap the **Photo Mode** box, then tap the **Panorama** box in the HUD. There are 3 panorama formats:

Panorama types capture characteristics:

 Vertical	ANAFI USA takes 8 photos in approximately 18 seconds
 Horizontal	ANAFI USA takes 10 photos in approximately 20 seconds
 360	ANAFI USA takes 42 photos in approximately 90 seconds

NOTE: The **Panorama** mode is the only photography mode which requires the drone to be flying before you can activate the shutter.

Press  **Media recording** on Skycontroller USA (or tap the HUD's **Soft shutter** button) to begin the panorama capture. ANAFI USA starts taking pictures and the bottom of the HUD displays a progress bar which fills with green as the capture unfolds.

To download the panorama pictures to Skycontroller USA, land ANAFI USA, Then, from the FreeFlight 6 USA homescreen, tap the  **SD CARD** box or the  **Gallery** box to display the media present on your microSD card. Like other media, panoramas are marked with their distinct icon and a green download box, which shows the size of the corresponding series of pictures.

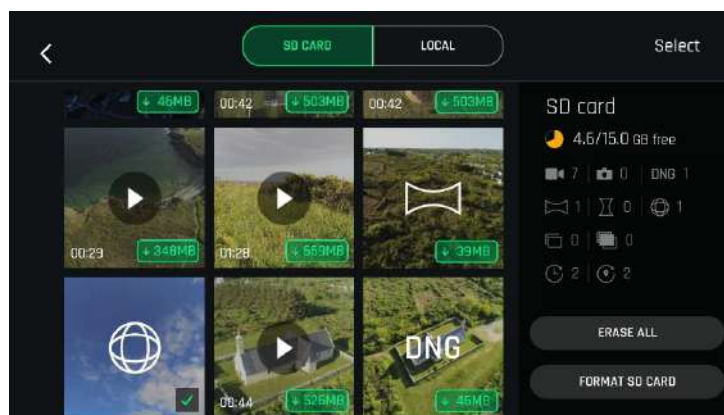

Tap the green box of the panorama you want to generate to start downloading the corresponding series of pictures to Skycontroller USA. When the download is complete, FreeFlight 6 USA displays a page from where you can delete the downloaded photos. Tap **Yes** to keep the originals on the microSD

card. Tap **No** to delete them.

Tap the **LOCAL** tab to access the device gallery, which contains only the media you have downloaded from ANAFI USA’s microSD card.

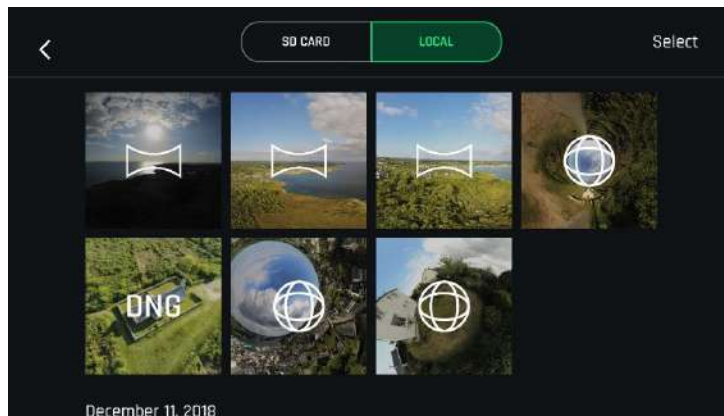

Finally, select the panorama you want to generate from your **LOCAL** gallery. FreeFlight 6 USA displays the following screen:

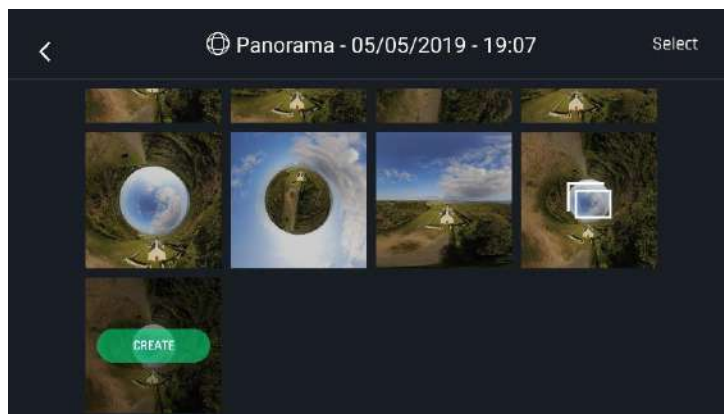

Tap **CREATE** to generate the panorama, or tap the other icon to access the series of individual pictures.

FreeFlight 6 USA may display one or two resolution options, up to 32 MP. Select the option you want to launch the generation. For the highest quality 360 panorama (32 MP), it can take several minutes.

When the panorama creation is complete, FreeFlight 6 USA displays the panorama and gives you the option to delete the original files.

For each **Vertical** or **Horizontal** panorama capture, you can generate one panorama only.

For each **360** capture, you can generate three different preset panoramas (**Sphere**, **Little Planet**, and **Tunnel**) and a potentially infinite number of custom panoramas, through the 360 editor.

The direct rendering of a custom panorama is a preview only. For each custom panorama you create, FreeFlight 6 USA completely reprocesses the data to minimize stitching issues and discrepancies.

Gimbal tilt control

ANAFI USA features a controllable gimbal (180° tilt range, nadir to zenith). Gimbal tilt is controlled with Skycontroller USA's **Gimbal tilt** trigger (left trigger). It is available in all video and photo modes, and in all manual piloting modes.

- To aim the gimbal toward the ground, push the **Gimbal tilt** trigger down.
- To aim the gimbal toward the sky, pull the **Gimbal tilt** trigger up.
- To reset the gimbal tilt to a horizontal position, press the  **Optics reset** button.

Zoom control

ANAFI USA features a 32x zoom. Zoom is controlled with Skycontroller USA's **Zoom** trigger (right trigger). It is available in all video modes, and in **JPEG RECT** photo mode (with an impact on the final resolution of your pictures). **WIDE** photo modes imply the use and rendering of all 21MP delivered by ANAFI USA's CMOS sensors. Zoom is deactivated in both WIDE photo modes.

- To zoom in on a subject, push the **Zoom** trigger down.
- To zoom out, pull the **Zoom** trigger up.
- To reset the zoom factor to 1x, press the  **Optics reset** button

FreeFlight 6 USA's HUD presents precise, decimal-by-decimal zoom information at all times, in the middle of the left-hand side of the screen.

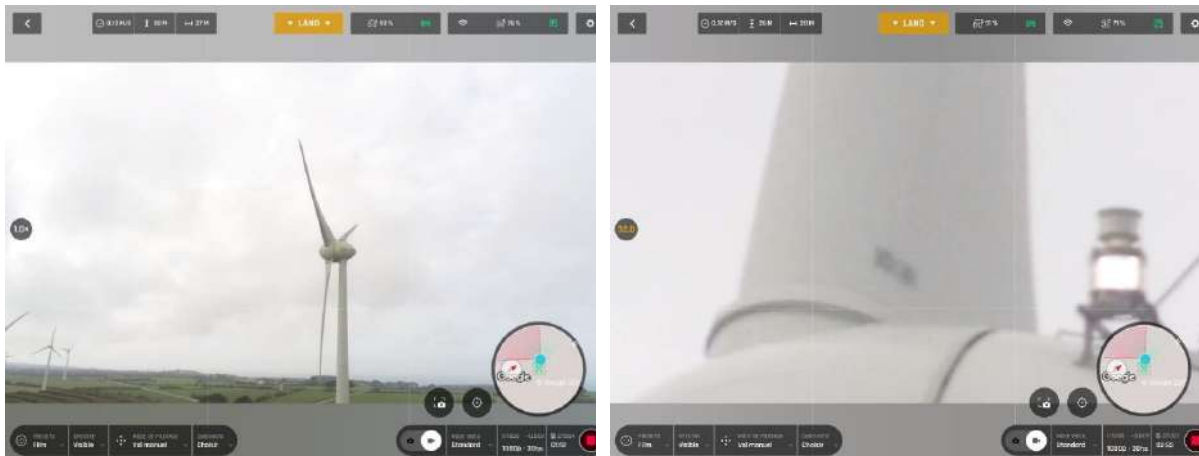

x1 zoom

x32 zoom

Camera Calibration

Correct horizon (exceptional procedure)

NOTE: Your ANAFI USA's camera has been factory-calibrated with high precision.

Unlike the calibration of ANAFI USA or that of the Skycontroller USA, which must be performed periodically, the camera calibration must not be performed unless it appears necessary, typically, after a crash. If you notice a tilted horizon on all your videos and photos, and if this tilt is always on the same side, access camera calibration to make your horizon perfectly straight again.

This feature is accessible from the ANAFI USA box on the FreeFlight 6 USA homescreen (or from the ANAFI USA box of the HUD) and from the **PREFERENCES / Camera** menu.

Before starting this procedure, you must position ANAFI USA on a flat and perfectly level surface, exactly perpendicular to any pattern containing straight lines you can use as horizon references. A set

square can help you check that a line on your floor is perpendicular to your wall.

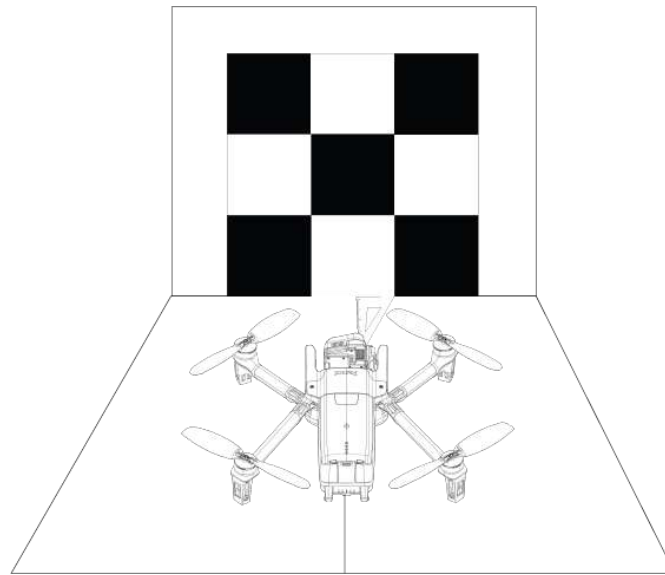

When ANAFI USA is correctly positioned, perpendicular to its straight horizon reference, press **Power** to power it on, along with the Skycontroller USA.

Access **Camera calibration** from the ANAFI USA box of the homescreen or the HUD of FreeFlight 6 USA, or from the **PREFERENCES / Camera** menu.

Select the **Correct horizon** option from the **Camera calibration** screen.



ANAFI USA: gimbal/camera calibration

The **Horizon correction** screen appears, showing white horizontal lines.

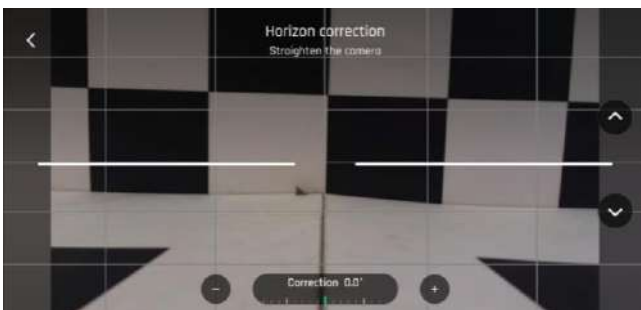

Gimbal/camera calibration: before

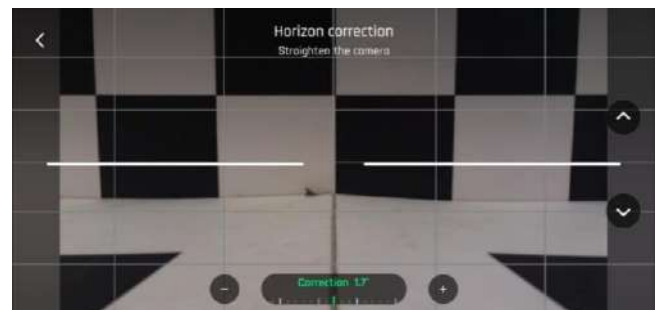

Gimbal/camera calibration: after

Tap **+ plus** or **- minus** until the artificial horizon of ANAFI USA matches the horizon reference facing the drone. Do not worry about vertical lines: as you can see from the screenshots, they do not appear straight or parallel on the gimbal calibration screen.

When you have straightened the tilt of the camera, tap the < **Back** icon on the top left of the screen to confirm your setting and exit camera calibration.

Gimbal calibration

Use this option to perform a gimbal calibration, similar to that which occurs after ANAFI USA is powered on.

NOTE: FreeFlight 6 USA may require you to carry out this procedure (as it may require you to perform a drone magnetometer calibration) before allowing you to fly ANAFI USA.

Camera's alignment (exceptional procedure)

Use this option to align the images of your visible and thermal spectrum cameras.

As the interface advises, due to cameras parallax, use the farthest possible object as your alignment reference, ideally, at least 16.3 m (53.5 ft).



ANAFI USA: Camera alignment, before



ANAFI USA: Camera alignment, after

NOTE: You can activate the zoom (right) trigger to magnify the view of your reference.

Tap **+ plus** or **- minus** on each axis to align visible and thermal views.

Tap < **Back** on the top left of the screen to exit the interface and confirm your settings.

Advanced image settings

ANAFI USA is set to deliver high quality and balanced 4K videos and 21MP photos, out of the box. However, there are multiple advanced image settings. This section is designed to help you exploit manual settings and develop your filming and photography styles.

To access the advanced image settings:

1. Tap the **Image settings** box of the HUD.
2. Tap **Auto** to select Automatic mode, or **PRO** to select Manual mode.

Additional settings boxes are unlocked.



NOTE: In **Auto** mode, the only setting accessible is Exposure value **EV**.

PRO	Pro mode: The pilot chooses the shutter speed s , and the ISO , and the White Balance WB .
AUTO	Auto mode: ANAFI USA chooses the Shutter speed s , the ISO value, and the White Balance WB , based on the surroundings.

Lock AE

FreeFlight 6 USA allows the pilot to lock the general exposure of a view, to fine-tune the framing of a shot and keep the desired exposure.

A **Lock AE** icon appears, to the left of the **HDR** icon (it replaces the **HDR** icon in **DNG+JPEG** photo format, as **HDR** is not available with this setting).

Tap the **Lock AE** icon to lock the exposure value to that of the current view. The icon turns yellow. A yellow **Lock AE** box appears under the **Next available action** box, at the center of the top bar of the HUD.

Move ANAFI USA around or tilt its gimbal to change the frame. The exposure settings remain as they were when you activated the function.

Tap the **Lock AE** icon again to deactivate the exposure lock. The icon reverts to white, and the yellow **Lock AE** box disappears.

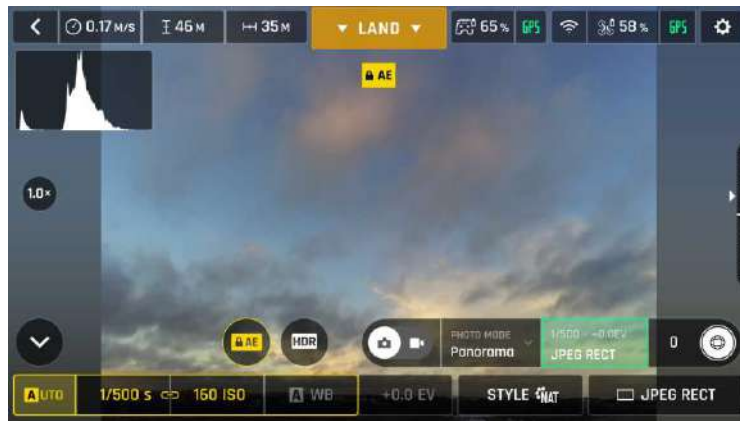

Exposure is locked on the sky

Lock AE Touch

With the **Lock AE Touch** (or **Spot AE**) function of FreeFlight 6 USA, you can also lock the exposure of a frame on any detail of any view.

To activate this function, follow the **Lock AE** procedure of the preceding section. When the exposure is locked, touch the part of the frame you want to base your exposure on. A yellow square animates around this spot and the yellow **Lock AE** box is replaced by a yellow **Lock AE Touch** box.



Exposure is locked on the top of the trees: shutter speed is set at 1/240 s

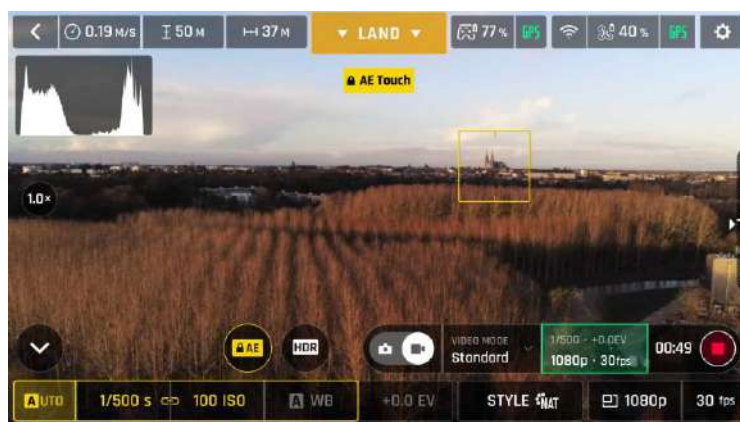

Exposure is locked on a building on the horizon: shutter speed is set at 1/500 s

HDR

HDR (high dynamic range) can enhance a video or a photo. The HDR option is available for **Standard** video mode **4K**, **2.7K** and **1080p** formats (regardless of framerate values) and **JPEG photos**.

To activate the HDR option, select a **Standard** video mode or a **JPEG** photo format from the relevant boxes of the bottom bar of the HUD. A white and round HDR icon appears on your screen, to the left of the photo/video trigger.

Tap the **HDR** icon. It turns yellow, and an HDR notice appears in black inside a yellow box, under the **next available action** box, at the center of the top bar of the HUD. Press the hard shutter button on your Skycontroller USA (or tap the soft shutter button of the HUD) to start filming in HDR or to take an HDR photo.

Tap the round HDR icon again to deactivate HDR. The yellow HDR box disappears from the screen.



HDR Off



HDR On

NOTE: You cannot modify **s**, **ISO** or **WB** values when the HDR mode is activated. However, you always keep control over your EV value. Activating (or deactivating) HDR stops any ongoing video recording.

Shutter speed (s)

The **s** value refers to the exposure time, in fractions of a second, where the shutter stays open to capture a still picture.

In **Auto** mode, ANAFI USA selects the best shutter speed and ISO value couple, in real time, depending on the scene and available light.

NOTE: Selecting a shutter speed deactivates the Auto ISO mode.

As ANAFI USA's f/2.4 aperture lenses lets in a lot of light, even compared to most professional SLR lenses, your drone can achieve very fast **s** values (down to 1/10000s) and capture very fast action. It can also be used for slow shots, up to 1 second for the photo mode.

NOTE: ANAFI USA can shoot pictures and videos when it is not flying. You can hold it in your hand and use it as a stabilized 4K video and photo camera.

Tap the **s** box to open the shutter slider.

Select a value to exit the **Auto** mode for shutter speed and ISO. This action also deactivates the EV slider.

Set the desired **s** value, then tap the **ISO** box to select an ISO value. The HUD reflects the chosen settings. If you get lost, tap **Auto** either on the **s** or the **ISO** slider to get back to **Auto exposure** and reactivate the EV slider.

ISO value (ISO)

The ISO value refers to the sensitivity of the sensor. The ISO value is linked to the shutter speed value. Both sliders activate when you deactivate the **Auto** mode and set a value for one, or the other. The lower the ISO value, the lower the sensitivity of the sensor, and the lower the image noise (digital grain). Therefore, under good lighting conditions, such as sunny daylight outside shots, select low ISO values (for example, between 50 or 200). 3200 ISO can be used to capture low light interior scenes, or exterior shots at dusk or dawn, for example.

By default, in **Auto** mode, ANAFI USA constantly adapts its ISO and shutter speed values to the scene it is filming. However, setting an ISO value for a whole shot or series of shots is advised for professional filming.

Tap the **ISO** box to open the ISO slider.

Select a value to exit the **Auto** mode for **ISO** and shutter speed. This action also deactivates the EV slider.

Set the desired ISO value, then tap the **s** box to select a shutter value. The HUD reflects the chosen settings. If you get lost, tap **Auto** either on the **s** or the **ISO** slider to get back to auto exposure and reactivate the EV slider.

White balance (WB)

White balance refers to the process of adjusting the colors in an image to accurately represent how they would appear under different lighting conditions, particularly in relation to the color temperature of the light source. Cold lights make the whites look blue. Warm lights make the whites look yellow. By default, in **Auto WB** mode, ensures that white objects appear neutral white, at all times. It adapts its WB value in real time.

However, setting a WB value for an entire shot is advised for professional filming. Stable WB facilitates the grading (color treatment) of videos.

Tap the **WB** box to open the white balance options.

Select the **WB** option that is best suited for your shooting conditions, your subject, or both. The HUD reflects the chosen settings and helps you make the best choice.



Auto WB



Incandescent WB



Fluo WB



Sunny WB



Cloudy WB



Shaded WB



WB 2 000 K



WB 10 000 K

Exposure value (EV)

The EV expresses the general darkness or lightness of a photograph or video. At +0.0 (zero) EV, ANAFI USA automatically adapts the shutter speed and the ISO value to deliver a perfectly balanced photo or video.

Tap the **+0.0 EV** box to activate the EV slider.

Slide your finger on the screen to the negative values on the left to darken your picture or video. Slide your finger on the screen to the positive values on the right to lighten your picture or video.



1.0 EV



+1.0 EV

Style

NATURAL

The **Natural** Style is the default ANAFI USA Style. It respects nature's colors and tones. Activate the **NATURAL** style from the **Style** box of the **Video/Photo** settings menu.

P-LOG

P-LOG style is an alternative Style to **NATURAL** style, both in video mode, and photo mode. This alternative imaging style reduces contrast and saturation. **P-LOG** style is ideal for videos and photos you want to edit and process using professional grading tools and filters. Activate the **P-LOG** style from the **Style** box of the **Video/Photo** settings menu.

INTENSE

Intense style is a second alternative Style to **NATURAL** style both in the video mode, and in the photo mode. It makes images more saturated and contrasted. Activate the **INTENSE** style from the **Style** box of the **Video/Photo** settings menu.

PASTEL

Pastel style is a third alternative Style to **NATURAL** style both in the video mode, and in the photo mode. It makes images less saturated, but it brings out their warmest tones. Activate the **Pastel** style from the **Style** box of the **Video/Photo** settings menu.

ADJUSTMENT

The **ADJUSTMENT** button, next to the **P-LOG** box, provides three additional settings for your **Normal** style still images and films:

Additional settings

Saturation	sets the intensity of the colors (from -2 to +2)
Contrast	sets the degree of difference between lightest and darkest parts of the image (from -2 to +2)
Sharpness	sets the distinction of detail reproduction (from -1 to +1)



All settings at minimal values

Tap the **RESET** button, on the right of the screen, to bring all values to 0 (zero).

Tap **< Back**, on the left of the screen, to confirm your settings, and exit the **ADJUSTMENT** menu.

Thermal Imaging

Thermal imaging, or infrared (IR) thermography, is the process of acquiring, measuring and analyzing thermal information from non-contact devices, such as ANAFI USA's FLIR Boson camera.

Thermal imaging devices transform invisible IR radiations, or heat transfers, into colored images the human eye can interpret and analyze.

To access ANAFI USA's thermography mode, either tap the **THERMAL** box on the homescreen of FreeFlight 6 USA or tap the **SPECTRUM** box on the lower bar of the HUD and select **Thermal**.

Presentation of the Thermal HUD (post-processing)

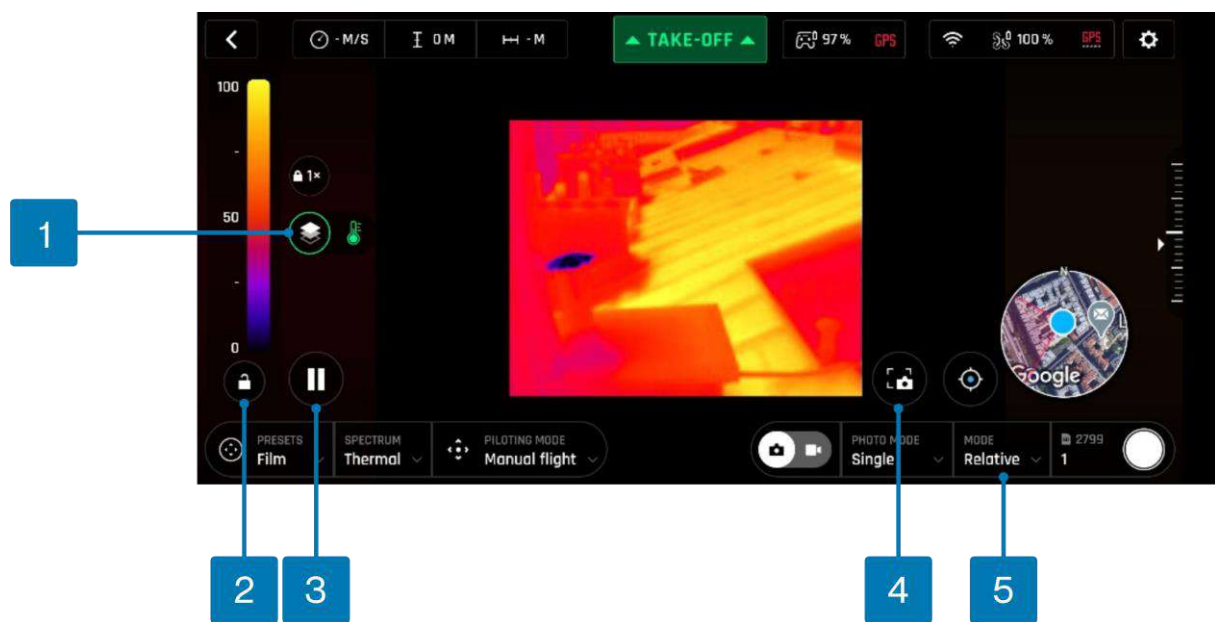

1. Spectrum blending
2. Lock scale
3. Pause view
4. Take a screenshot
5. Thermal mode selection

*(the thermometer icon indicates only the IR spectrum is displayed)

NOTE: When post-processing is activated (default value), the **Pause** view and **Lock scale** buttons are available. They disappear when post-processing is deactivated (refer to the "[PREFERENCES / Thermal / Thermal post-processing](#)" section of this guide for more information).

As for the Visible Spectrum, you can record both **Thermal photos** and **videos**. You can choose through the **photo/video** toggle button in the lower bar of the HUD (or among additional settings, as in the Thermal HUD screen capture).

When in **Thermal Spectrum**, the choice of photo modes is limited to three options, each of which delivering 1280x720 rectilinear JPEG thermography images:

- Single shot
- Timelapse (10, 30, 60, 120, or 240 seconds intervals between shots)
- GPS Lapse (5, 10, 20, 50, 100, or 200 meters spherical intervals between shots)

The **Thermal Spectrum** video mode is limited to a single option. ANAFI USA shoots 9 frames per second 1280x720 thermography MP4 (H264) videos.

You can capture screenshots, directly to your Skycontroller USA, through the dedicated  **Screenshot** button. This feature is available when filming and enables you to extract a still image from a film without stopping the recording.

NOTE: ANAFI USA is a multicamera system (two EO lenses for one visible camera, one thermographic camera). However, photo or video mode selection is independent from the cameras. In other words, for example, switching from Visible Spectrum photo mode calls the last Thermal Spectrum photo mode that was selected; similarly, switching from Thermal Spectrum video mode calls the last Visible Spectrum video mode that was selected.

Relative Thermal mode

The Relative mode is the default thermography mode of ANAFI USA, which is activated upon first access to the Thermal HUD.

The Relative mode provides a quick overview of a scene's temperature range. In this mode, even slight heat differences materialize as strong contrasts.

Its main specificity is that the scale it displays, on the left of the HUD, matches by default the temperature range of the scene ANAFI USA is filming, on a 0 to 100 graduated scale.

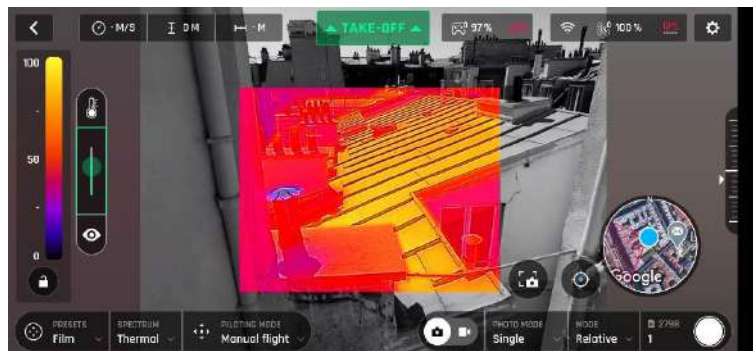

Relative Thermal mode (balanced blending between IR and visible)

However, when the post processing is activated, the lock button enables you to temporarily lock the scale to the temperature range of any scene. This is especially useful if you must reframe your scene to include part of the sky. The sky always appears as a cold element, which disturbs the scale.

Spot Thermal mode

The Spot Thermal mode of ANAFI USA isolates hot or cold.

Use the **inverted arrows button** (under the scale, on the left of the screen) to toggle from hot to cold (or from cold to hot) and slide your finger along the scale to adapt the threshold of the scale to your scene and highlight only the coldest or hottest spots.

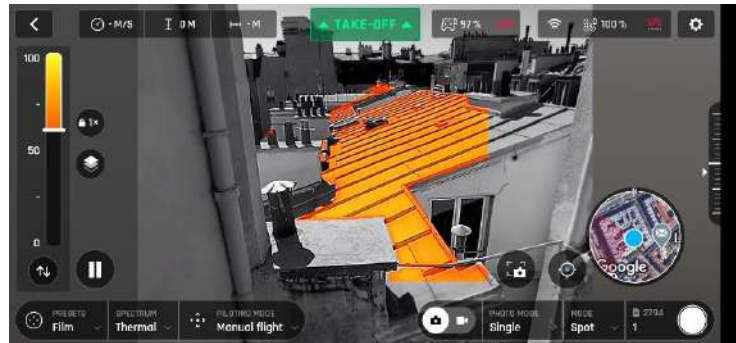

Spot Thermal mode: only the hottest elements of the scene are colored.

NOTE: In Spot Thermal mode, the thresholds you set manually are only reset when you tap the **RESET THERMAL SETTINGS** button in the Thermal Preferences tab.

Thermal analyzer mode

The Thermal analyzer feature of FreeFlight 6 USA provides quick thermal analysis, directly from your Skycontroller USA.

This function gives you full control over the on-screen rendering of any thermography video or photo you have taken with ANAFI USA. From the analyzer, you can:

- access Thermal Preferences directly from the preview's **Preferences** icon, top right;
- navigate inside your thermography videos;
- modify the thermography modes (Relative, hot and cold spots) and their associated thresholds at any point of any video or on any photo;
- modify the blending between Visible and Thermal spectrums;
- save an unlimited number of screenshots.

However, Thermal analyzer videos cannot be saved or exported by FreeFlight 6 USA – even if the Skycontroller USA enables you to record your screen.

To analyze a thermography media, access your **LOCAL** FreeFlight 6 USA **Gallery** and open a thermal video preview or a photo.

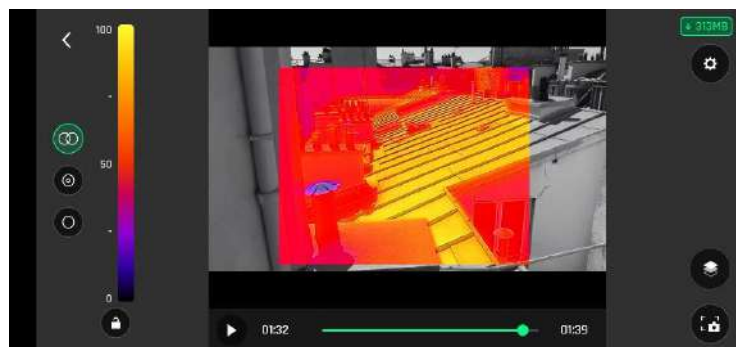

Thermography video preview, Relative mode

Tap the green **ANALYZE** box.

The photo displays or the video plays in Analyzer mode. As shown on the following screen captures (extracted from a video analysis), the interface gives you access to most options available for filming.







Same image, (hot) Spot mode

Cineshots (visible spectrum only)

ANAFI USA features a series of automated shots, which enable you to capture scenes professionally.

Ensure that you have selected the video settings you require and tap **CINESHOTS** in the bottom bar of the HUD to access Cineshots.



Tap one of the following Cineshots to select it:

-  **360°**
-  **Reveal**
-  **Spiral**
-  **Epic**

For each, two options appear. ANAFI USA films all your Cineshots automatically if you have free space on your microSD card.

360°

When  **360°** cineshot is activated, ANAFI USA maintains its position and altitude, and rotates slowly and completely around its axis to capture a full panorama.

Tap **Right** or **Left** to select the direction you want your drone to rotate, and to activate the  **360°**. After a countdown on the HUD, ANAFI USA starts its rotation. An animation flashes on your screen, and the  **360°** box progressively fills with green as the cineshot unfolds.



Reveal



When  **Reveal** cineshot is activated, ANAFI USA tilts its camera toward the ground and starts moving forward in a straight horizontal line. Slowly, over 30 or 60 meters, the camera gimbal tilts up, revealing the scenery in front of ANAFI USA.

CAUTION: Before you activate the  **Reveal** cineshot, verify that the area in front of ANAFI USA is safe, and clear of obstacles.

Tap **30m** (small-arrow icon) or **60m** (large-arrow icon) to select the range of your reveal shot, and activate it. After a countdown on the HUD, ANAFI USA tilts its camera down and starts moving forward. An animation flashes on your screen, and the  **Reveal** box progressively fills with green as the cineshot unfolds.

Spiral



When  **Spiral** cineshot is activated, ANAFI USA tilts its camera to the ground and starts moving up, in a straight vertical line. Slowly, as it climbs to 30 or 60 meters, ANAFI USA carries out a full 360° rotation around its axis, then its camera tilts up progressively, panning over the scenery along a 180° rotation. ANAFI USA finishes the  **Spiral** cineshot with a 180° angle, compared to its starting point.

CAUTION: Before you activate the  **Spiral** cineshot, verify that the area above ANAFI USA is safe, and clear from obstacles. Do not activate the  **Spiral** Cineshot under obstacles, for example trees or bridges.

Tap **30m** (small-arrow icon) or **60m** (large-arrow icon) to select the range of your spiral shot, and activate it. After a countdown on the HUD, ANAFI USA tilts its camera down and starts moving up

and rotating. An animation flashes on your screen, and the  **Spiral** box progressively fills with green as the Cineshot unfolds.

Epic

When  **Epic** cineshot is activated, ANAFI USA moves away backward in a smooth ascending line, keeping its subject in the center of its frame for 30 or 60 meters. The  **Epic** cineshot gives the best results when ANAFI USA starts from a position close to its subject.

CAUTION: Before you activate the  **Epic** cineshot, verify that the area behind ANAFI USA is safe, and clear from obstacles.

Tap **30m** (small-arrow icon) or **60m** (large-arrow icon) to select the range of your epic shot, and activate it. After a countdown on the HUD, ANAFI USA starts moving backward and upward. An animation flashes on your screen, and the  **Epic** box progressively fills with green as the Cineshot unfolds.

CAUTION: Activate and monitor all cineshots with care. Always check your automated shot flight plan is clear from obstacles and is safe, always retain visual contact with ANAFI USA, and always be ready to reclaim control of your drone.

NOTE: Any action on any stick of Skycontroller immediately terminates the current cineshot.

Piloting modes

Tap the **PILOTING MODE** box in the bottom bar of the HUD of FreeFlight 6 USA to access the piloting modes options.

Tap a mode to select it. Each mode is associated with a specific behavior.

Manual flight

The Manual flight mode is ANAFI USA's default mode. It enables you to pilot the drone and fully control its camera tilt and zoom.

When you release the commands in Manual flight mode, ANAFI USA hovers in the same position.

Cameraman

The Cameraman mode enables you to pilot ANAFI USA around an object or a subject and keep them in the center of your frame.

Frame the object or subject you want to film and fly around.

Tap the **PILOTING MODE** box in the bottom bar of the HUD to access the options. Tap **Cameraman** to select this piloting mode.

You must enter a fixed horizon configuration into the Cameraman mode, or the mode does not lock. Draw a rectangle with your finger on your screen, around the object or subject you want ANAFI USA to follow, or double tap the object or subject. When your target is locked, the blue rectangle turns to green and the orange LAND box at the center of the top bar of the HUD turns red and displays STOP. ANAFI USA's frame centers on your target, inside the green box.

Drag the green box to the area of the frame where you want your target to remain at.

Fly ANAFI USA around your target. The drone keeps your target in the part of the frame you have selected. If you push the right joystick of the Skycontroller USA to the left, ANAFI USA circles around your target clockwise. If you push the right joystick of the Skycontroller USA to the right, ANAFI USA circles around your target counterclockwise.

When the Cameraman mode is activated, ANAFI USA manages the gimbal tilt to keep the target in the frame. The left trigger of the Skycontroller USA is deactivated in this mode. However, you can still control the zoom, with the right trigger.

When you release the commands in the Cameraman mode, ANAFI USA hovers and rotates to keep following the target.

To end the following of your target, tap the red **STOP** box at the center of the top bar of the HUD.

When no target is selected, or when the following of the target has been ended by the pilot, ANAFI USA's behavior is similar to that of the Manual flight mode.

CAUTION: Activate and monitor the Cameraman mode with care. Always check your flight plan and the trajectory of your subject are clear from obstacles and safe, always retain visual contact with ANAFI USA, and always be ready to stop the following (tap the STOP box of your HUD) in case a danger or any sort of unexpected obstacle arises.

Follow Me

The Follow Me mode enables ANAFI USA pilots to have their drone follow them in action.

WARNING: Fly ANAFI USA at least 5 meters (15ft) high and 10 meters (30ft) in front of you, facing you. A red alert at the bottom of the HUD on FreeFlight 6 USA informs you if you are too close to ANAFI USA, or if it is flying too low.

Frame yourself.

Tap the **PILOTING MODE** box in the bottom bar of the HUD to access the options. Tap **Follow Me** to select this piloting mode.

Both a drone GPS synchronization and a controller GPS synchronization are imperative to activate this mode. Upon first activation, the following screen appears:



Follow Me GPS warning

Tick the box on the bottom left on the page if you do not want this warning to appear again when no prerequisite is missing. Tap **FLY** to access the Follow Me mode.

Select one of the three Follow Me options (refer to in-app explanations for details):

- Track
- Lock
- Dynamic

NOTE: Parrot recommends you only use the Dynamic option in completely open and unobstructed areas.

Draw a rectangle with your finger on your screen, around yourself. When ANAFI USA has a lock on you, the blue rectangle turns to green and the orange **LAND** box at the center of the top bar of the HUD turns red and displays **STOP**.

By default, ANAFI USA keeps you in the center of the frame, but you can drag the green box to the area of the screen you want to remain at. If you push the right joystick of the Skycontroller USA to the left, ANAFI USA circles around you clockwise. If you push the right joystick of the Skycontroller USA to the right, ANAFI USA circles around you counterclockwise.

In the **Follow Me** mode, ANAFI USA manages the gimbal tilt to keep you in the center of the frame. Therefore, the left trigger of the Skycontroller USA is deactivated in this mode. However, you can still control the zoom, with the right trigger.

When you release the commands in the **Follow Me** mode, ANAFI USA keeps following you from a constant distance if you are moving. If you remain in the same position, ANAFI USA stops and stays focused on you.

To have ANAFI USA stop tracking you, tap the red **STOP** box at the center of the top bar of the HUD.

When no target is selected, or when the tracking has been ended by the pilot, ANAFI USA's behavior is similar to that of the Manual flight mode.

The **Follow Me** mode features a series of exclusive Dronies which can be activated as you move, always keeping you in the center of the frame. For each Dronie, two options are available (they are listed in brackets):

Dronie options

Orbit (left or right)	ANAFI USA circles around you in a full 360°.
Parabola (10 or 30 m)	ANAFI USA flies in an arc over your head, gaining 10 or 30 meters in altitude and turning 180° at its peak.
Tornado (10 or 30 m)	ANAFI USA performs a double Orbit around you, one up 10 or 30 meters, the other down 10 or 30 meters, back to its original height.
Boomerang (30 or 60 m)	ANAFI USA flies away from you for 30 or 60 meters, with an ascending angle following that of the starting gimbal tilt, then comes back to its starting point.

To select a **Follow Me** Dronie, make sure you are in the Follow Me mode and that ANAFI USA is tracking you.

Tap the **Select Dronie** box in the bottom bar of the HUD.

Tap a Dronie to select it. Tap the option you have chosen to activate the Dronie. After 2 seconds, ANAFI USA starts moving around you. The corresponding Dronie box fills with green as the Dronie unfolds.

CAUTION: Activate and monitor the Follow Me mode and each Dronie with care. Always check your flight plan is clear from obstacles and safe, always retain visual contact with ANAFI USA, and always be ready to stop the following (tap the **STOP** box of your HUD) in case a danger or any sort of unexpected obstacle arises.

NOTE: To optimize the drone's tracking, always make sure you remain visible by ANAFI USA. Do not let an obstacle obstruct the camera's view and do not hide in the shadows, or ANAFI USA could lose track of you.

Smartdronies

ANAFI USA features four Smartdronies:

The **Orbit**, **Parabola** and **Boomerang** Dronie can be accessed through this menu, refer to the above section for details about the **Boomerang** Dronie. The smartest of ANAFI USA's dronies is the **Dolly Zoom**.

Frame yourself, or a group of people, with ANAFI USA: keep the drone at least 5 meters away, between 1 and 2 meters above the ground.

WARNING: Verify that the flight path of your drone is perfectly clear: at least 30 meters behind it, flat and without obstacles.

Tap **Smartdronies** from the **PILOTING MODE** box menu.

Both a drone GPS synchronization and Skycontroller USA GPS synchronization are imperative to activate this mode. Upon first activation, the same warning page appears as for the **Follow Me** mode. Tick the box on the bottom left on the page if you do not want this warning to appear again when no prerequisite is missing. Tap **FLY** to access the **Smartdronies** mode.

Tap the **Dolly Zoom** Dronie to open its three options.

How to prepare your map

This chapter describes how to prepare a map for flight. There are 2 ways to prepare a map:

- Save your future flying area map on FreeFlight 6 USA while connected to the internet, then use it offline in the field.
- Import your own custom maps to Freeflight6 USA without an internet connection.

Save future flying area maps online for offline use

You can use this tool to prepare a satellite view of your next destination. The satellite view displays during the flight even if you do not have an internet connection in the field.

1. Ensure that the Skycontroller USA integrated tablet is connected to the internet.
2. Ensure that the map engine interface setting is set on **GOOGLE MAP**
3. Tap the **Load map** tile on the FreeFlight 6 USA home screen.
4. A satellite view screen opens. Scroll to the area that you intend to fly over.
5. Tap **Prepare the map**.

A green bar appears which displays the progress of your map preparation.

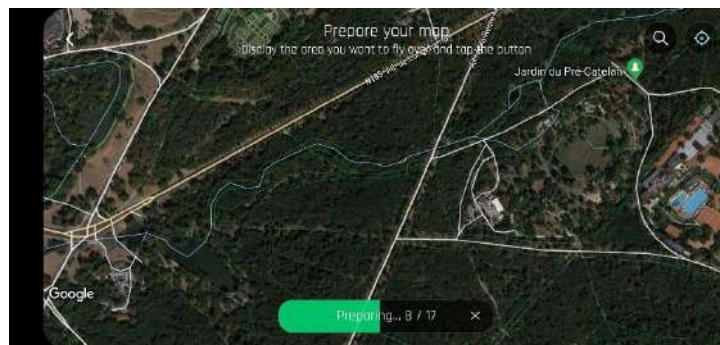

The map of your future mission is then saved to the FreeFlight 6 USA application memory. The map remains available even when Skycontroller USA is offline.

Import custom maps to FreeFlight 6 USA

You can import your own map files to FreeFlight 6 USA including MBTiles, PNG, and DTED maps.



Map engines

FreeFlight 6 USA features 2 options for the map engine used. Each map engine uses a different type of map file. You can import offline maps for both engines. You must change the **Map Engine** in FreeFlight 6 USA depending on which type of map you choose:

Map Engine	File type
GOOGLE MAP	PNG Tile
MAPLIBRE	MBTiles

IMPORTANT: When you use the **MAPLIBRE** map engine instead of **Google Map**, the minimap is always hidden.

To change the map engine FreeFlight 6 USA:

1. Tap  **Settings**.
2. The **PREFERENCES** menu opens, tap  **Interface**.
3. Scroll down to **Map Engine**.
4. Tap **GOOGLE MAP** or **MAPLIBRE**.

Upload custom maps

IMPORTANT: FreeFlight 6 USA automatically renames duplicate files by adding a number in parentheses after the file name, for example: MyMap(1). Parrot recommends that you name each map file differently before you transfer the map file in order to easily distinguish between 2 regions.

1. Set the Skycontroller USA to maintenance mode. To activate the Skycontroller USA maintenance mode, refer to section "[Skycontroller USA Maintenance Mode](#)" of this guide for more information.
2. Connect your Skycontroller USA to the PC
3. Copy the file(s) to the desired folder on the Skycontroller USA tablet (Recommended folder: **FreeFlight 6 USA\Custom maps**)
4. Return to the FreeFlight 6 USA home screen and tap the **Load map** tile.
5. The **Prepare your map** screen opens, tap  **Download Custom Maps** at the bottom right.
6. The **Custom Maps** screen opens, tap **Import** at the top right.
7. The device file manager opens, tap the 3 dots at the top right, then tap **Show Internal Storage** to display the internal memory of the tablet.

IMPORTANT: If this option is already activated, and the text **Hide internal storage** is displayed instead, do not tap it and go to the next step.

8. Tap the  three dashes on the left of the screen and then tap **Galaxy Tab**
9. A screen opens which shows the internal memory of the tablet.
10. Search for the map file(s) in the folder you selected in step 6 (Recommended folder: **FreeFlight 6 USA\Custom maps**)

For .mbtiles map files and .png map files, the import process finishes here. Return to the FreeFlight 6 USA home screen by following sub steps A – D. For DTED map files, continue with step 11 below.

- A. Tap **< Back**. The **Prepare your map** screen opens again.
- B. Tap **< Back**. The home screen opens again.
- C. Tap **FLY** on the FreeFlight 6 USA home screen. The HUD screen opens.
- D. Tap the circle showing the map on the bottom right of the screen. You can now see your map. You may need to zoom to the correct location.

11. Select the file(s) to add the map to the **Custom maps** list.

A green joystick symbol  indicates that the map is downloaded to the Skycontroller USA tablet memory.

NOTE: For PNG tile maps, when you next launch FreeFlight 6 USA, the new PNG tile map appears as an overlay of the default (Google) map.

IMPORTANT: Before you attempt to upload the map to ANAFI USA, ensure that the drone is up to date, turned on and connected to Skycontroller USA.

12. To upload the map to the drone, navigate to the **Custom Maps** screen.
13. place your finger anywhere on the map line and slide to the left.



14. Tap **Upload**.

A progress bar appears. When the upload completes, the drone symbol turns green.

15. Return to the Prepare your map screen to view the loaded map.

NOTE: For DTED maps only, several outline colors define the type of map: white (DTED0), Orange (DTED1), green (DTED2). The DTED map outline is a solid line if the map is saved on the drone. If the DTED map is only saved on the controller, the map outline is a dashed line.

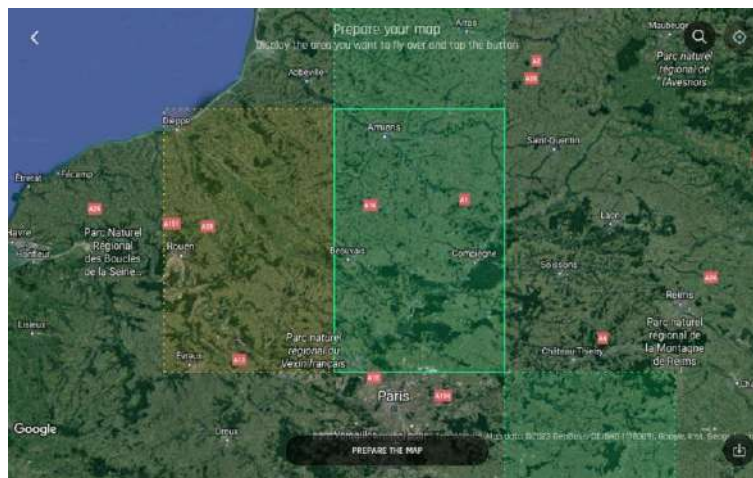



When the DTED map is loaded, the ground elevations and heights are available in the telemetry element at the top left of the HUD.

To delete a previously uploaded map, repeat step 12 and tap **Delete**, which replaces **Upload**.

Uploaded DTED are visible in the FreeFlight 6 USA interface and can be used for the CoT function. Refer to the [“Cursor on Target”](#) section of this guide for more information.

NOTE: if you see a loading error on FreeFlight 6 USA when you load a DTED map, it is likely that the file is corrupted. Repeat with another map or reload an uncorrupted version of the file.

If a .mbtiles map file is corrupted, it may force FreeFlight 6 USA to crash. If you experience difficulties due to a corrupted .mbtiles map, follow this procedure:

1. Revert to the **GOOGLE MAP** map engine:
 - a. Tap **Settings**.
 - b. The **PREFERENCES** menu opens, tap  Interface.
 - c. Scroll down to **Map Engine**.
 - d. Tap **GOOGLE MAP**.
2. Return to the FreeFlight 6 USA main screen and tap the **Load map** tile.
3. The **Prepare your map** screen opens, tap  **Download Custom Maps** at the bottom right.
4. On the **Custom Maps** screen, swipe left on the corrupted map until you see the **Delete** tile.
5. Tap **Delete**, a menu opens. You must confirm if you want to delete the file.
6. Tap **YES**.

How to create your own custom DTED and GeoTIFF maps online

Alternatively, you can create DTED or GeoTIFF maps online, and then upload these maps to FreeFlight 6 USA. Follow these steps to create, download, and import custom maps.

1. Navigate to the USGS Earth Explorer, available at <https://earthexplorer.usgs.gov/>.



NOTE: You must create an account, and log into USGS to download and order scenes.

2. Search for the area you want to create a map for.
3. To create a grid, click on the map at least 3 times to place map pins.
4. Click the **Data Sets** tab.
5. Click **Digital Elevation** to expand the menu.
6. Click **SRTM** to expand the menu.
7. Click the checkbox beside **SRTM 1 Arc-Second Global**.
8. Click the **Results** tab.
9. Click the download icon. The **Download Options** window opens.
10. Click **Download** beside **DTED 1 Arc-Second**. This option has the highest resolution.

NOTE: If you decide to download the **GeoTIFF 1 Arc-second** map, you must convert this file into a format compatible with FreeFlight 6 USA. Refer to the following chapter on how to convert a GeoTiff map into a MBTiles map or PNG tile map.

Convert a GeoTIFF map to a MBTiles map or a PNG tile map

The free QGIS software allows you to convert GeoTIFF maps into .mbtiles files for the **MAPLIBRE** map engine, or .png files for the **GOOGLE MAP** map engine. Follow this procedure to convert your files:

1. Launch [QGIS](#). Double-click on **New Empty Project**, under **Project Templates**.
2. Drag and drop your GeoTIFF file from your computer into the main QGIS window to bring your GeoTIFF file into the software's main interface.
3. Ensure that your GeoTIFF file has been imported onto your PC screen. It appears in the **Layers** menu on the left-hand side of the screen.
4. In the top bar navigation menu, click on **Processing**, then on the first option in the drop-down menu,  **Toolbox**. The conversion interface opens on the right-hand side of the screen.
5. To create a .mbtiles file, follow sub step A), to create a .png file, follow sub step B):
 - A. .mbtiles file - In the  **Toolbox**, double-click on **Raster Tools**, then click on **Generate XYZ tiles (MBTiles)** in the **Processing Toolbox** (See the blue box).
 - B. .png file - In the  **Toolbox**, double-click on **GDAL**, then double-click on **Raster miscellaneous**, then click **gdal2tiles** in the **Processing Toolbox** (See the green box). Click **Run** to start the conversion.

NOTE: If you follow step 5.B to create a .png file, the conversion process is complete after you click **Run**, however, you must compress all new folders (.zip format) from the **Output directory**. Do not rename the folders. The conversion can take over 1 hour, depending on the size of the original file.

If you follow step 5.A, continue with step 6 for the .mbtile conversion process.

NOTE: The GeoTIFF map in the example below is displayed in grayscale.

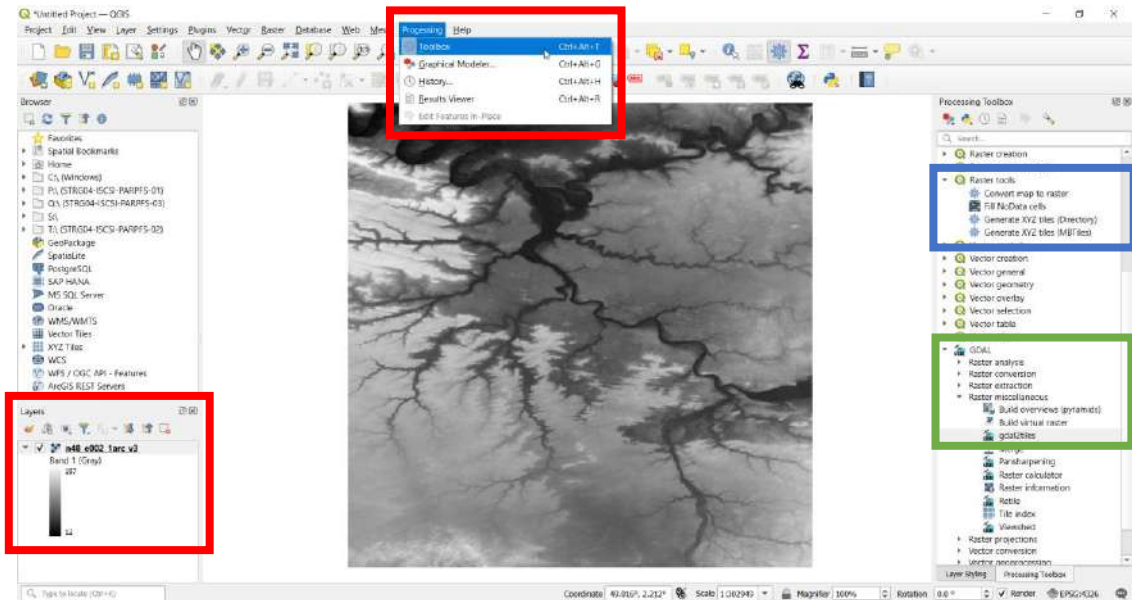

6. The **Generate XYZ tiles (MBTiles)** menu opens. Under the **Parameters** tab, in the **Extent** field, click the \vee down arrow to open a drop-down menu.
7. Click **Use Current Map Canvas Extent**.
8. From the drop-down menu, click **Draw on Map Canvas**.
9. Choose the appropriate zoom levels.
10. Under the **Parameters** tab, in the **Output file (for MBTiles) [optional]** field, click the \vee down arrow to open a drop-down menu.
11. Click **Save to file...**
12. Name the file, and click **Save**.
13. Click **Run**. The conversion can take more than one hour, depending on the size of the map and the parameters of the previous steps.

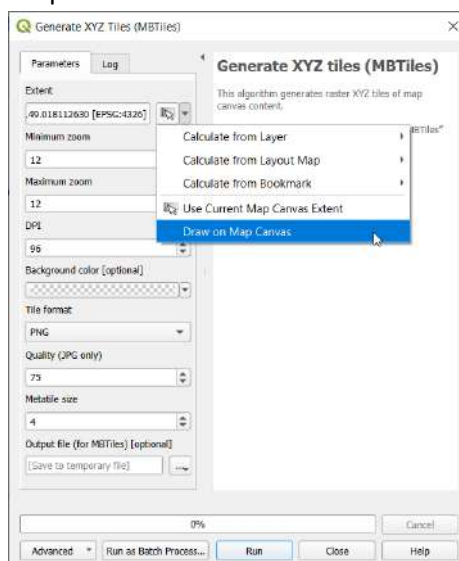

Cursor on Target



Overview

The Cursor on Target (CoT) function provides location coordinates of the ANAFI USA, the Skycontroller USA, and the object or person that you are targeting, as well as the distance between these 3 elements.

CoT HUD Overview

To display the **Cursor on Target** element and the white crosshairs in the center of the screen, tap  **Target** in the upper right corner.

The drone reference box (in green) appears at the right-hand side of the screen, along with 3 action buttons:

	Coordinate display lock button: Tap to lock the element state to make it easier to copy the coordinates. Tap again to unlock the element. A yellow outline indicates that the element is locked. NOTE: You cannot take a screenshot when the lock is activated.
	Calibration button: Calibration is optional but recommended. Calibration improves the accuracy of the measurement. An orange icon indicates calibration is recommended.
	Switch reference button: The drone coordinates, and the distance between the drone and the target and the azimuth, are displayed by default, press this button to switch to user reference (Skycontroller USA): the element then displays height/distance and azimuth between the target and the user.

The white crosshairs in the center of the screen allow you to aim at a particular point of interest to obtain the relevant coordinates.

To remove the Cursor on Target element, tap  **Target** again.

Cursor on Target interface

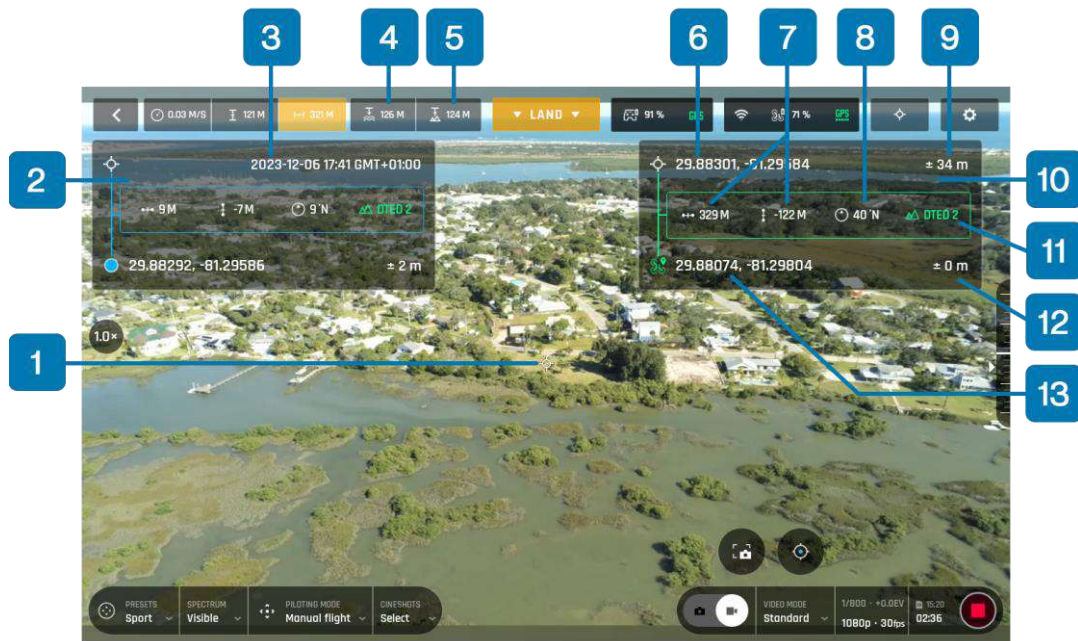

1. Crosshairs
2. Skycontroller USA/pilot reference (in blue)
3. Date and time of flight operation
4. **MSL** (Mean Sea Level) altitude
5. **AGL** (Above Ground Level) altitude
6. Target coordinates in the center screen crosshairs
7. **Horizontal** and **Vertical** distance of the target reference (controller or drone)
8. **Azimuth** in relation to north
9. \pm Target coordinates accuracy
10. Drone reference (in green)
11. Map type
12. \pm Reference coordinates accuracy (controller or drone)
13. Reference coordinates (controller or drone)

In the example screenshot above, the target is 329m northeast of the drone, and 9m north of the pilot's position.

When a DTED map is correctly uploaded to FreeFlight 6 USA, the Cursor on Target function adds additional information to the FreeFlight 6 USA HUD:

1. Telemetry data: **MSL** and **AGL** altitudes

There are two telemetry indicators in addition to the **ATO** (Above Take Off) height relative to the takeoff point.

NOTE: If you do not upload a DTED map, FreeFlight 6 USA reverts to FLAT map mode. In FLAT map mode the **MSL** altitude and the **AGL** altitude are not available and are replaced by dashes.

2. CoT elements: controller and drone

The CoT element appears on the right of the screen when activated.

Changing the element reference

Tap **Switch reference** to change the element reference (Drone or Skycontroller USA).

NOTE: During flight, only one element box is displayed. However, when you take a screenshot, the

screenshot shows the telemetry data of both the drone and controller.

NOTE: In drone reference, if the target is under the drone, the distance between the drone and target is negative, for example, when the drone looks down. If the target is above the drone, the distance between the drone and target is positive, for example, when the drone looks up.

In Skycontroller USA (pilot) reference, if the target is under the pilot, the distance between the pilot and target is negative, for example, if the pilot is at the top of a mountain and the drone aims at the bottom of the mountain. If the target is above the pilot, the distance between the pilot and target is positive.

Different distance display modes

Tap the rectangle (green for the drone, blue for the controller) containing the horizontal/vertical distances to switch the display to an oblique distance, i.e., the **Slant** distance between the reference and the target.

Long press on the coordinates to copy the data.

The coordinates do not show under the following conditions:

- No connection between ANAFI USA and the Skycontroller USA
- No GPS data from ANAFI USA
- No GPS data from the Skycontroller USA.
- The pilot aims at the sky

CoT Calibration

You can improve the location measurement accuracy with the CoT calibration. By aiming at a known point (the Skycontroller USA), the drone evaluates the biases of its position/orientation sensors and applies these corrections to the CoT measurements.

To calibrate:

1. Tap the **Calibration** action button on the right of the CoT element. A pop-up appears at the top right of the screen informing you to **Precisely aim at the pilot and click the media button on the controller.**
2. Position the drone in the green area indicated in the diagram below:

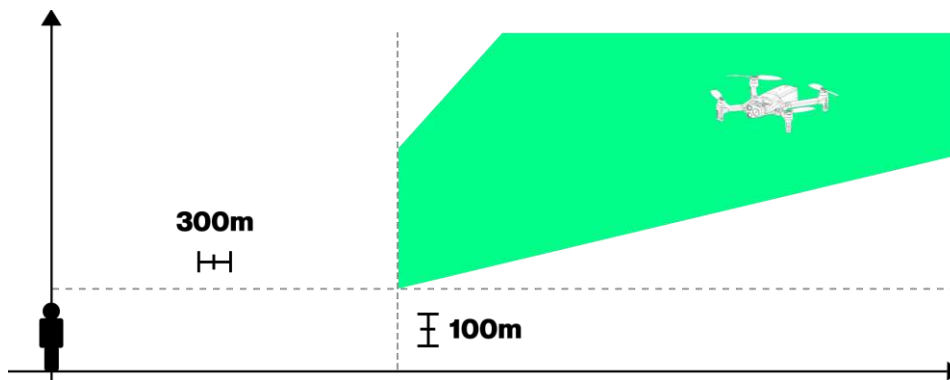

IMPORTANT: To calibrate the system, there must be a minimum horizontal distance of 300 meters (1000 ft) between ANAFI USA and Skycontroller USA, and ANAFI USA must have a minimum altitude of 100 meters (330 ft) in order to have a gimbal angle between 17° and 60°.

NOTE: You can only perform the calibration in the green zone. If the calibration is launched in an area outside of the green zone, FreeFlight 6 USA displays a pop-up alert to inform you that ANAFI USA is outside the calibration zone. When the drone passes through an area in which calibration is possible, FreeFlight 6 USA automatically returns to the CoT calibration screen.

3. Aim at Skycontroller USA accurately with or without zooming depending on the distance. Aiming accuracy directly influences the accuracy of the CoT measurements.

WARNING: ANAFI USA cannot detect a bad calibration. Ensure that you aim at Skycontroller USA correctly. The accuracy indicator does not consider the aiming error since it considers the calibration to be correct.

4. Validate the calibration by pressing the media button as indicated on the pop-up in step 1.

Calibration is complete.

NOTE: No media is recorded or saved during calibration.

In case of a bad calibration, you can restart the calibration at any time.

Calibration is valid for the entire flight.

TIP: Parrot recommends that you perform the calibration each time after the drone is stored. It is not necessary to calibrate every time the battery is changed, but it does increase the coordinates precision estimate. If calibration is recommended, the  **Calibration** icon turns orange (each time the drone is started). After calibration is complete, the icon turns white.

FLAT maps

If no DTED maps are uploaded to the drone, it is not possible to know the ground height of the target. The drone considers the ground as FLAT at the altitude of takeoff.

Limitations related to the use of FLAT maps:

1. Take-off altitude is considered as a reference of 0. When taking off from a high point (a carrier for example) the coordinates will be wrong (For example: at 500m/200m, the CoT will have 125m of difference from the real ground level if you took off from 40m high). If you are at sea, Parrot recommends loading the DTED 0 of the area, to have the altitude 0 in the correct place.
2. If you fly below the altitude of the takeoff point (and the distance between the drone and ground level becomes negative) then the CoT ceases to be valid. Similarly, in DTED when you are very close to the ground (1-3m) the drone may estimate itself "under" the ground. Ideally, you should be at least 10m above the ground to use the CoT properly. Parrot recommends you always fly with a DTED map, or possibly to load the DTED 0 of the area.

Measurement accuracy

Different parameters influence the accuracy of the measurement:

1. The distance between the drone and target - the smaller the distance between the drone and the target, the more accurate the measurement.
2. The quality of the CoT calibration – see the previous paragraph for more information.
3. The quality of the magnetometer calibration.

IMPORTANT: Parrot strongly recommends that you perform this calibration if you change location, or if the drone was close to a metallic or magnetic mass. You must maintain a minimum distance from anything that could cause magnetic disturbances, for example:

- A regular car – minimum distance: 1m
 - An armoured vehicle – minimum distance: 7m
4. The angle to the target - the shallower the angle, the less accurate the measurement is. The optimal gimbal angle is between 17° and 60° (if you are out of the angle range, calibration is not possible).
 5. The type of mapping - the DTED 2 is more accurate than the DTED 1, which is more accurate than the FLAT map.
 6. Terrain relief:
 - DTED maps give an average altitude of the area, so they are not accurate if the terrain changes abruptly (at the foot of a cliff for example)
 - The DTED 1 provide an altitude of 90m per square
 - The DTED 2 provide an altitude of 30m per square
 - If no DTED map is loaded, the drone assumes a flat ground, at the level of its takeoff altitude.
 7. Fixing the GPS before the drone takes off.

Parrot recommends waiting for the green GPS icons before taking off. Taking off without GPS can decrease the performance of the entire CoT. The height estimation between the pilot and the drone is based on GPS.

CoT parameters

You can modify some parameters specific to the CoT function in the options menu:

1. Coordinates system: **LATLNG, MGRS, UTM** and **DMS**

Go to **PREFERENCES > Interface > Coordinates system**

2. Time zone (of screenshots): in Local or UTC

Go to **PREFERENCES > Interface > Time zone**

Refer to the “[PREFERENCES / Interface](#)” section of this guide for more information.

Screenshots

Take a screenshot by pressing  **Screenshot** on the Skycontroller USA.

If the CoT element is deployed, the screenshots are taken with the telemetry and the CoT of the drone and the Skycontroller USA. The time and date of the screenshot is displayed in the element on the left-hand side.

NOTE: If the CoT element is not deployed, the screenshots are taken without telemetry. Screenshots are not possible when the coordinates are locked. This avoids coordinates unrelated to the image being transmitted to a third party, which could be a source of confusion.

Map-based flying modes

Flight Plan

Flight Plan enables you to fully prepare and configure your flights and filming sessions.

Tap **Flight Plan** from the **PILOTING MODE** box menu. The map of your surroundings opens full screen. If you are not connected to ANAFI USA, the minimized live view is black.



- | | |
|-----------------------------|-----------------------------|
| 1. Initial waypoint | 7. Waypoint number |
| 2. Waypoint altitude | 8. Camera direction |
| 3. ↑↓ PLAN OPTIONS | 9. Waypoint distance marker |
| 4. FLIGHT PLAN saves | 10. Slider |
| 5. PILOTING MODE box | 11. Current waypoint |
| 6. Undo/Redo | |

Parrot recommends that you modify the settings of the flight plan before you begin. Tap **↑↓ PLAN OPTIONS**. A new window opens with 2 options:

PLAN OPTIONS

Landing on last way	No/Yes	Choose if the drone lands on the last waypoint, or if the drone hovers.
Automatic progressive course	No/Yes	Choose if the drone stops briefly at each waypoint, or if the drone transitions smoothly from waypoint to waypoint.

Tap on the **FLIGHT PLAN** box, a window opens. Tap **New**.

Choose the location of your initial waypoint, ideally, very close to your intended take-off point. Tap the screen to create the waypoint. The waypoint appears as a green circle. The white figure in the center represents the drone altitude, and the white arrow represents the camera direction.

Change the direction of the ANAFI USA's camera by pressing and holding on the white arrow. Rotate the arrow to the desired camera direction.

Tap the map to create more waypoints. The distance between the current waypoint and the previous waypoint appears on the flight path.

Tap the distance between the waypoints to change the figure from waypoint distance to drone speed between those 2 waypoints. Use the slider to increase or decrease the speed.

To change the height of an individual waypoint, tap the desired waypoint. Drag the slider on the right of the screen to modify the altitude. In the example above, ANAFI USA climbs from 3 meters at the initial waypoint to 30 meters for the following waypoints.

To create a Point of Interest, press and hold on the screen. A menu opens with 2 options: **Point of interest** / **Close**.

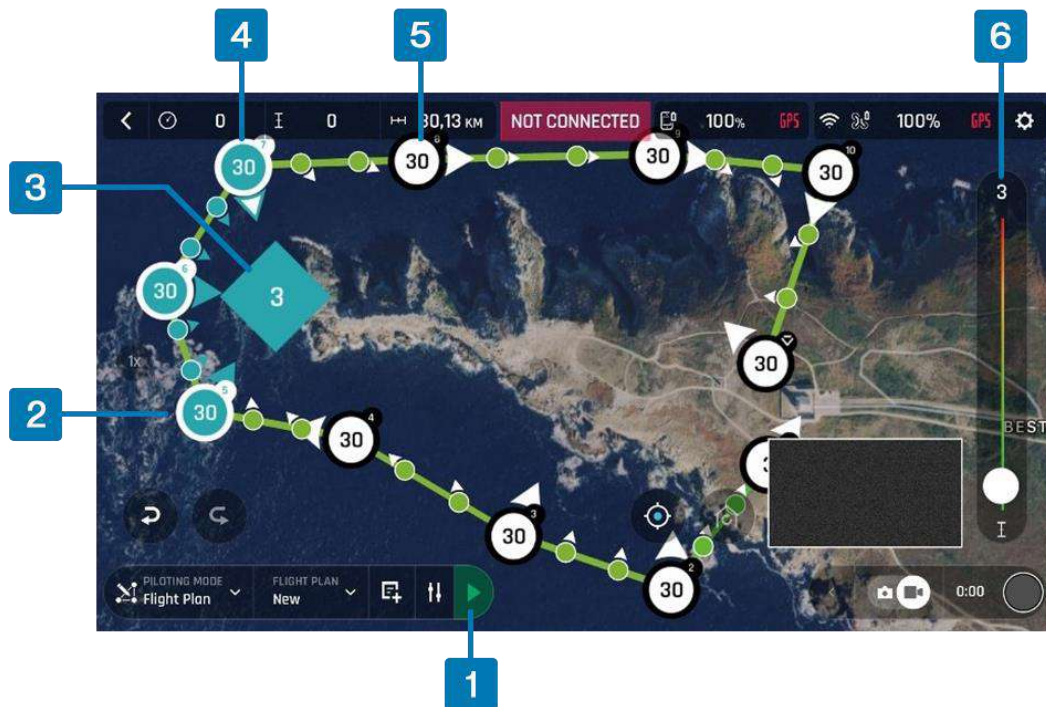

1. Start Flight Plan button
2. Waypoint linked to POI
3. Currently selected **Point of interest** (POI)
4. Final waypoint linked to a POI (indicated by a white arrow with blue border)
5. Independent waypoint
6. Altitude of POI

Tap **Point of interest** to add the POI. The POI appears as a blue square diamond. The white figure in the center represents the POI altitude. Drag the slider on the right of the screen to modify the altitude.

NOTE: If you want a more precise method to define the drone speed between waypoints, waypoint altitude, or POI altitude instead of using the slider, press and hold on the relevant figure. A menu bar appears. To modify the drone speed, tap **Speed**. To modify the waypoint or POI height, tap **Altitude**. A window opens where you can enter the desired value.

When you select a POI, all waypoints turn white to indicate that you can now link the waypoints to the POI.

Tap a waypoint to link it to the POI.

When you link a waypoint to a POI, the waypoint arrow rotates toward the POI, and the arrows turn from white to blue. The arrow of the last waypoint you select remains white but has a blue border around the white arrow.

To unlink a waypoint from a POI, tap the POI, then tap the waypoint that you want to unlink.

Tap the POI to confirm your choices. The POI changes from a blue diamond to a white diamond with a blue border. Blue waypoints are linked to the blue POI. During the entire blue segment of the flight, ANAFI USA's camera will stay focused on the blue POI, enabling you to achieve a flyby shoot. Green waypoints remain independent from the POI.

NOTE: POIs are color coded. Each POI you create is a different color from the previous. When you link a waypoint to a POI, the waypoint changes color to the corresponding POI color.

You can modify waypoints and POIs at any time. Tap the waypoint or POI to change the height, and drag the icon to change the location.

To remove a waypoint or a POI, tap undo on the left-hand side. Alternatively, press and hold on the waypoint or POI icon. A menu bar appears, tap **Delete**.

Start your flight plan

Tap the **PILOTING MODE** box on the HUD to display the options. Select **Flight Plan**. The last plan you created appears.

Tap the green arrow on the right of the left bottom bar of the **Flight Plan** interface to begin the **Flight Plan**. ANAFI USA takes off, flies to the first waypoint and starts the **Flight Plan**. At the end of the **Flight Plan**, depending on your settings and depending on your version of FreeFlight 6 USA, ANAFI USA lands at, or hovers over, the last waypoint you created.

WARNING: Monitor every Flight Plan with extreme care. Always verify the drone's route is safe, and clear of obstacles. Always maintain visual contact with ANAFI USA, and always be ready to stop the Flight Plan (tap the **STOP** box of your HUD or reclaim commands of the drone) in case of danger or unexpected obstacles.

Touch & Fly: Waypoint

Waypoint is the default **Touch & Fly** mode. It enables you to fly ANAFI USA to any point on the map. Tap **Touch & Fly** from the **PILOTING MODE** box menu. The map of your surroundings opens full screen. The live image captured by ANAFI USA is minimized in the bottom right corner of your screen.

Tap a point on the map to select a destination for ANAFI USA. This point is marked as a white circle with a green border. For each new Waypoint **Touch & Fly** session, FreeFlight 6 USA asks you to confirm the first destination of ANAFI USA as on the following screen capture. Tap the green **TAP HERE TO START** box, ANAFI USA flies toward its designated destination. Use the slider on the right of the screen to control the drone's altitude (the green figure inside the circle) when it reaches its destination.

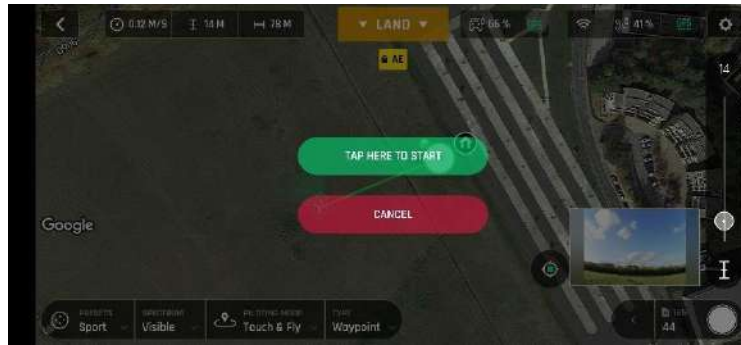

Touch & Fly Waypoint: first destination confirmation screen

CAUTION: Activate **Touch & Fly** Waypoint with care. After the initial confirmation, any tap on the map will immediately send ANAFI USA to the corresponding spot. Parrot recommends you set your FreeFlight 6 USA filming or photography options before activating the **Touch & Fly** Waypoint mode. If, by mistake, you send ANAFI USA toward a dangerous area, tap the **STOP** box at the center of the top bar of the HUD, or firmly reclaim commands from the Skycontroller USA.

Touch & Fly: POI

To access the POI **Touch & Fly** option, tap the **Type** box from the lower bar of the HUD, and select **POI**. In **POI** mode, tap a point on the map to create a point of interest, marked as a white square diamond with a blue border, labelled with a **POI** icon. Control the height of the **POI** (the blue figure inside the square diamond) through the slider on the right. This controls the tilt of the gimbal, while you use the Skycontroller USA to fly around your target. ANAFI USA remains focused on the **POI**.



Touch & Fly: POI

Tap **STOP** from the red box at the center of the top bar of your screen to halt ANAFI USA, or to reset a **POI**.

From the **Smartdrones** box, next to the **Type** box of the lower bar of the HUD, you can also activate **Smartdrones** (Orbit, Parabola, Dolly Zoom, Boomerang) of your **POI**.

Refer to the "[Smartdrones](#)" section of this guide for more information.

Maintenance and troubleshooting

This section describes basic procedures to maintain your drone and troubleshoot most issues you may encounter using ANAFI USA. In addition, drone and controller reset procedures can be useful before a change of operator or operating structure.

Changing propeller blades

Propeller blades are delicate pieces of equipment and are instrumental for flight integrity. Even minor contacts with external elements (walls, tree branches, etc.) can damage their structure. Damage is not necessarily visible.

As a safeguard measure, ANAFI USA is programmed to cut its motors instantly in case of impact to one of its propeller blades. Always control your drone carefully.

TIP: Replace propeller blades if they sustain even minor contacts with the environment. Replace propeller blades every 50 flight hours, as part of scheduled maintenance.

ANAFI USA propeller blades can be replaced, instantly without tools. Follow this procedure to replace a propeller blade:

1. Unfold the arm that supports the blades which require replacement.
2. Hold the motor (round rotating part) of the propeller between your left thumb and index finger.
3. Unfold the blades.
4. Pinch the propeller hub (between the blades) with your right thumb and index.

A. blades: unscrew used/damaged A blades (Front left & rear right) counterclockwise and screw new ones clockwise.

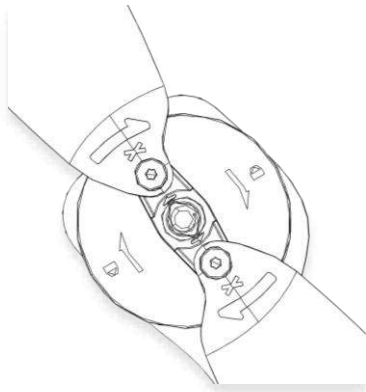

B. blades: unscrew used/damaged B blades (Rear left & front right) clockwise and screw new ones counterclockwise.

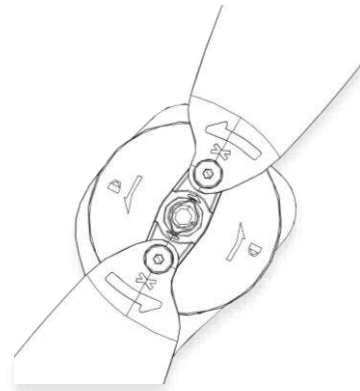

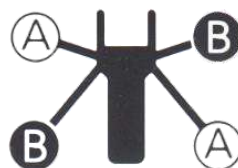

Verify that your blades respect the following diagram before setting up ANAFI USA for its next flight.



You can purchase propeller blades and ANAFI USA smart batteries separately. Find an ANAFI USA spare parts reseller [here](#).

Rebooting all systems

When the ecosystem does not perform as expected, the first procedure is to power off and reboot all elements of the ecosystem. Rebooting all systems can solve connectivity issues (black screen, white noise, etc.):



1. Press  **Power** to power off ANAFI USA.
2. Close the FreeFlight 6 USA application on your Skycontroller USA.
3. Reboot your Skycontroller USA.
4. Press  **Power** to power on ANAFI USA.
5. Wait for synchronization between Skycontroller USA and ANAFI USA: check that the left trigger of the Skycontroller USA activates the drone's gimbal to ensure the synchronization is complete.

Reinstalling FreeFlight 6 USA

If you must delete and reinstall FreeFlight 6 USA later, ensure that you back up all Skycontroller USA FreeFlight 6 USA media, as media may be deleted along with the application.

ANAFI USA drone hard reset

Hard resetting ANAFI USA reverts ANAFI USA's most recent firmware to its original state. Parrot recommends the drone hard reset as a first intent procedure for several issues, notably gimbal calibration troubles.

1. Verify that a compatible microSD card is inserted into ANAFI USA.
2. Power ANAFI USA on (short press on the battery's  **Power** button).
3. Wait for the gimbal to calibrate (or for the gimbal calibration to fail).
4. Press and hold the battery's  **Power** button. After 8 seconds the battery's LED lights up in red.
5. Release the battery's  **Power** button. ANAFI USA powers off briefly then reboots.

Resetting the Skycontroller USA

Resetting the Skycontroller USA reverts the controller back to its latest firmware update. It cleans all logs and credentials and restores the original ecosystem's Wi-Fi SSID and password.

To reset the Skycontroller USA, ensure that it is not connected to any drone, or the drone will initiate a take-off sequence.

Press and hold the controller's  **Take-off/Land**,  **Optics reset**, and  **Media recording** buttons for 15 seconds, then release the 3 buttons.

NOTE: The LED starts flashing after 10 seconds, but you must hold the buttons for an additional 5 seconds.

The Skycontroller USA reboots. The reset is successful.

The same procedure can be performed safely, even with a drone connected, through the **Reset** button of the Skycontroller USA page, in FreeFlight 6 USA.

WARNING: When the Skycontroller USA reboots, the connection between the drone and controller is lost.

ANAFI USA's smart battery hard reset

A hard reset of ANAFI USA's battery can correct battery issues. Parrot recommends a battery hard reset whenever the battery's behavior is unexpected.

You must reset your battery if:

- the battery behavior is not consistent with the information in the “*Smart LiPo Battery*” chapter.
- the battery does not power on ANAFI USA.

Follow this procedure to hard reset the smart battery:

1. Connect the smart battery to a power source.
2. Regardless of the battery's behavior, press and hold its power button for 15 seconds.
3. Release the  **Power** button.



The battery's LEDs run successively in green and red, then flash alternatively in green.

The battery's hard reset is complete.

TIP: Replace smart batteries after 300 charge/discharge cycles to ensure lasting performance.

Recover ANAFI USA

In the event of a hazardous situation, follow this procedure:

1. Press  **RTH** on the Skycontroller USA to cause the drone to return to its home position.
2. If the drone does not return, attempt to initiate an automatic landing by pressing the  **Take-off/Land** button on the Skycontroller USA.
3. Try to locate the ANAFI USA position.
4. Ensure that this event does not cause a subsequent hazardous situation based on its last known position.

WARNING: Hazardous circumstances may result in a situation where normal use of ANAFI USA is not respected. Read and respect the operational requirements described in the checklist appendix 1.

Drone end of service life

Refer to the Flight Safety Guide manual provided inside the packaging to find complementary information on how to recycle this product.

The propeller blades and the carry box are made of plastic, they can be disposed of in a recycle bin.

All the electronic devices (ANAFI USA, Skycontroller USA, smart battery) must be returned to a collection point (e.g. stores, recycling center) to be recycled. It is indicated by the following logos:



Frequently asked questions

What do I do if I experience a connectivity issue (black screen, white noise, thermography camera activation failure, frozen or lagging stream)?

Reboot all systems (refer to the relevant procedure in the earlier section of this guide).

What do I do if my ANAFI USA's gimbal does not calibrate?

Hard reset ANAFI USA (refer to the relevant procedure in the earlier section of this guide).

What do I do if my ANAFI USA does not power on?

Ensure that your smart battery is "awake". Plug it into a power source to take it out of wintering mode. Its LED should start flashing to acknowledge that it is charging. Parrot recommends you always fully charge your smart battery before you fly ANAFI USA.

What do I do if my battery shows a strange behavior (flashing LED, red LED, etc.)?

Reset the smart battery (refer to the relevant procedure in the earlier section of this document).

What do I do if my ANAFI USA is connected to the Skycontroller USA, but won't take off when I hit the take-off button?

The drone or controller boxes of the homescreen of FreeFlight 6 USA indicate either that:

- you must update your Skycontroller USA, your ANAFI USA, or both;
- or you must calibrate your ANAFI USA's gimbal;
- or you must carry out a magnetometer (drone) calibration;
- or you must calibrate your Skycontroller USA.

What do I do if my ANAFI USA flips over at take-off?

The propeller blades have been improperly installed. Remove all propeller blades and reinstall them properly and carefully, following the instructions enclosed in all ANAFI USA propeller blades packs.

What do I do if my Skycontroller USA does not synchronize with my ANAFI USA?

1. Verify that no device is connected on ANAFI USA's Wi-Fi network, with FreeFlight 6 USA running.
2. Pair your ANAFI USA to your Skycontroller USA (refer to the relevant procedure in the earlier section of this document).

What do I do in the unlikely event that my ANAFI USA has sustained a crash?

IMPORTANT: You must change all your propeller blades before attempting another flight. Propeller blades are instrumental for flight integrity and delicate pieces of equipment. Minor crashes may not show visible signs of damage to their structure.

1. Set up ANAFI USA for a flight.
2. Check the ANAFI USA page of FreeFlight 6 USA. Any permanently damaged element (gimbal or motor) appears in red. If an element is damaged, refer to point 8 below.
3. If no element is damaged, perform the calibration(s) requested by FreeFlight 6 USA (gimbal, magnetometer, or both).
4. Fly ANAFI USA, take pictures and videos.
5. Check your ANAFI USA pictures and videos to see if your drone's horizon is offset.
6. If your horizon is offset, perform the **Correct horizon** procedure of FreeFlight 6 USA's **Camera Preferences**
7. If the **Correct horizon** function cannot make your horizon straight again, it means a part of

your gimbal is deformed and your drone requires service and a new calibration. Refer to point 8 below.

NOTE: If the crash damaged a component of ANAFI USA which is essential to a safe flight (such as its vertical camera or its ultrasonic sensor), your drone will not be able to take off and a FreeFlight 6 USA alert will tell you to contact your Parrot Support Partner.

How do I set the FreeFlight 6 USA application as the default application when starting the Skycontroller USA?

1. Tap the **Settings** icon on the Samsung Galaxy tab.
2. Tap **Applications** then select FreeFlight 6 USA, and tap **Remove Defaults**.
3. Restart the Skycontroller USA.
4. After restarting, a pop-up opens, tap **Always open FreeFlight 6 USA when Skycontroller USA is connected**.
5. Tap **OK** to confirm.

Appendix 1: Operational checklist

This checklist has been developed with military ANAFI series drone pilots. It provides useful information to every ANAFI USA pilot.

Update & calibration

FreeFlight 6 USA	SYSTEMATICALLY UP TO DATE
Skycontroller USA	SYSTEMATICALLY UP TO DATE
ANAFI USA	SYSTEMATICALLY UP TO DATE
Magneto calibration	OK
Skycontroller USA calibration	OK
Gimbal calibration	OK

IMPORTANT: Parrot strongly recommends that you regularly refer to the [Release Notes ANAFI USA](#) available on the Parrot website, to ensure that you have the latest versions of the drone and controller firmware, and FreeFlight 6 USA App. If you are an offline user, you must contact your local Parrot Partner or Parrot Contact to obtain the .apk file to perform an offline system update. Refer to the "[FreeFlight 6 USA offline update via APK file](#)" chapter for more information.

Skycontroller USA & ANAFI USA OFF

Arms	unfolded, locked
Arms mechanical lash	NONE
Lens cap	OFF
Check drone and gimbal	OK
Check propellers	intact, free, fully screwed on.
Check Skycontroller USA	OK, 100 % charged
ANAFI USA battery	Intact, 3 hooks engaged in drone, 100% charged
ANAFI USA battery LED	4 x OK
ANAFI USA battery temp	OK
MicroSD card	Inserted, with sufficient memory.

Skycontroller USA & ANAFI USA ON

Skycontroller USA	ON, flashing light to dark blue LED
ANAFI USA	ON, gimbal calibration OK
SCUSA/ANAFI USA Wi-Fi link	steady blue LED on SCUSA,
L trigger moves gimbal:	OK
FreeFlight 6 USA:	launched
Image feed & telemetry:	OK
Flight mode selection:	MANUAL
RTH Height set:	(20 m to 100 m)
Max altitude	set
Max distance	set
Geofence	activated if needed
Image settings	OK
Check Stick Mode	Inverted/Special mode
Map on app	OK
MicroSD card	Formatted
Battery levels	XXX% (report on flight log if ≠ from 100%)
Global reactivity	set
Camera tilt speed	set
Inclination	set
Vertical speed	set

Rotation speed	set
Before take-off	
ANAFI USA GPS signal	Red/Orange/Green (check status matches mission)
Skycontroller USA GPS signal	Red/Green (check status matches mission)
Flight mode	MANUAL
Weather	OK
Take-off Zone	Clear
Drone status	Check
Take-off/Land command	Take-off
After take-off	
Precise Home Set	Depending on conditions/10 secs or 10 meters
Check Stick Mode	Inverted/Special mode
Flight mode	MANUAL
Check flight commands	OK
Check gimbal	OK
Video feed	OK
Video latency	OK
Drone status	Check
Before landing	
Flight mode	MANUAL
Weather	OK
Landing Zone	Clear
Drone status	Check
Take-off/Land command	Land
After landing	
Check engines off	OK
Drone status	Check
Arms mechanical lash	NONE
Skycontroller USA	Off, Stored away
Check drone/gimbal/propellers	OK
Lens cap	ON
ANAFI USA Battery	OFF
ANAFI USA arms	Folded.
ANAFI USA drone	Stored away
MicroSD card	Stored away
Cables	Stored away
Documents	
Flight & batteries info	Report on flight log